



FRB

RETURN FILTERS



DESCRIPTION

Tank top return line filter, inbuilt breather

MATERIALS

Head: Aluminum alloy
Cover and Bowl: Polyamide
Bypass valve: Polyamide
Seals: NBR Nitrile
Indicator housing: Brass

PRESSURE

Max. working: 700 kPa (7 bar)
Collapse, differential for the filter element (ISO 2941):
300 kPa (3 bar)

BYPASS VALVE

Setting: 170 kPa (1,7 bar) \pm 10%
250 kPa (2,5 bar) \pm 10%

FLOW RATE

Qmax 140 l/min

WORKING TEMPERATURE

From -25° to +110° C

COMPATIBILITY (ISO 2943)

Full with fluids: HH-HL-HM-HV-HTG
(according to ISO 6743/4)
For fluids different than the above mentioned,
please contact our Customer Service.
please contact our Customer Service.

HYDRAULIC DIAGRAM

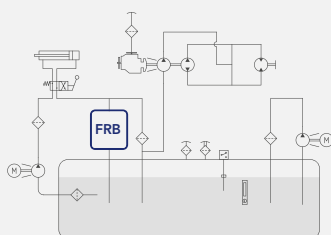

Is this datasheet the latest release? Please check on our website



FRB

RETURN FILTERS



ORDERING AND OPTION CHART

F	R	B	COMPLETE FILTER FAMILY					FILTER ELEMENT FAMILY	E	R	B
			SIZE & LENGTH	11	21	22	23	SIZE & LENGTH			
			PORT TYPE								
			B = BSP thread	B	B	B	B				
			N = NPT thread	N	N	N	N				
			S = SAE thread	S	S	S	S				
			PORT SIZE								
			04 = 1/2"	04	-	-	-				
			06 = 3/4"	06	06	06	06				
			08 = 1"	-	08	08	08				
		B	BYPASS VALVE								
			B = 170 kPa (1,7 bar) - 250 kPa (2,5 bar) for F+ media	B	B	B	B				
		N	SEALS					SEALS			
			N = NBR Nitrile	N	N	N	N				
			FormulaUFI MEDIA					FormulaUFI MEDIA			
			FA = FormulaUFI.MICRON 5 $\mu\text{m}_{(c)}$ $\beta > 1.000$	FA	FA	FA	FA				
			FB = FormulaUFI.MICRON 7 $\mu\text{m}_{(c)}$ $\beta > 1.000$	FB	FB	FB	FB				
			FC = FormulaUFI.MICRON 12 $\mu\text{m}_{(c)}$ $\beta > 1.000$	FC	FC	FC	FC				
			FD = FormulaUFI.MICRON 21 $\mu\text{m}_{(c)}$ $\beta > 1.000$	FD	FD	FD	FD				
			CC = FormulaUFI.CELL 10 μm $\beta > 2$	CC	CC	CC	CC				
			CD = FormulaUFI.CELL 25 μm $\beta > 2$	CD	CD	CD	CD				
			CLOGGING INDICATOR								
			05 = nr. 2 x 1/8" ports, plugged	05	05	05	05				
			30 = pressure gauge, rear connection	30	30	30	30				
			P4 = SPDT pressure switch	P4	P4	P4	P4				
			P6 = SPDT pressure switch	P6	P6	P6	P6				
			ACCESSORIES								
			W = without	W	W	W	W				
			C = with polyester air breather	C	C	C	C				
			D = with metal air filter	D	D	D	D				
			ACCESSORIES								
			W = without	W	W	W	W				
			H = with dipstick	H	H	H	H				

SPARE PARTS

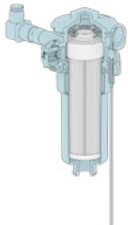
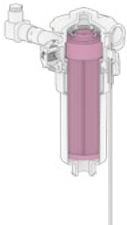
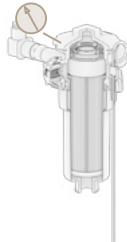
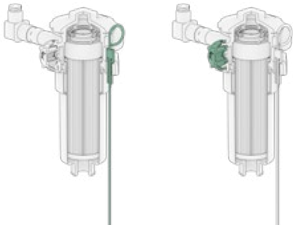
FILTER HOUSING				FILTER ELEMENT				CLOGGING INDICATOR				ACCESSORIES			
															
B	R	B		B	N										

SPARE SEAL KIT

NRB

FRB11	521.0016.2
FRB21	521.0017.2

SPARE SPRING

FRB11	008.0208.1
FRB21	008.3014.1

INSTALLATION DRAWING

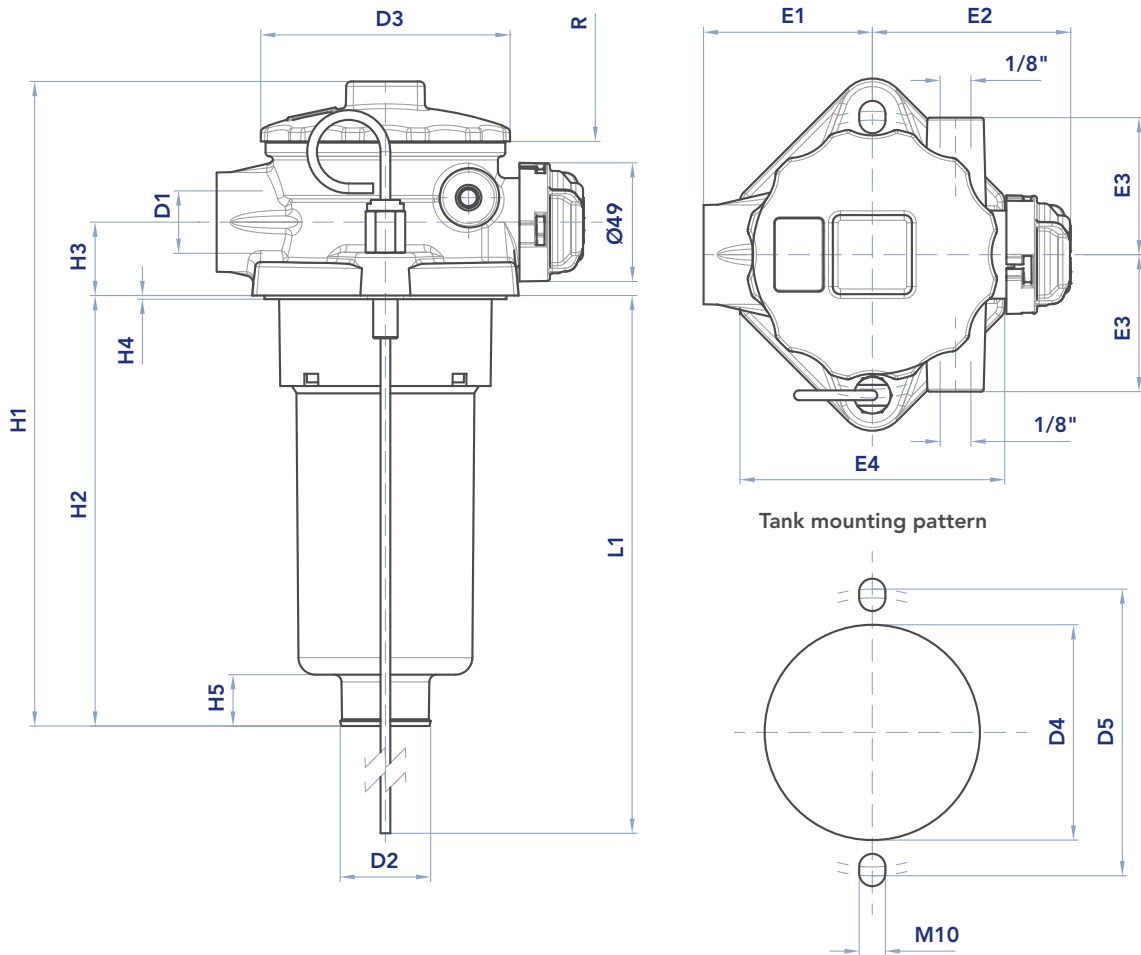

FILTER HOUSING

	D1	D2	D3	D4	D5	E1	E2	E3	E4	H1	H2	H3	H4	H5	L1	R	Kg
FRB11	1/2"-3/4"	28	75	60÷63	82÷88	50	70	28	77	243	178	24	2	16	380	220	0,40
FRB21	3/4" - 1"	36	104	87÷91	110÷115	70	83	37	108	200	110	30	1,5	22	370	190	0,84
FRB22	3/4" - 1"	36	104	87÷91	110÷115	70	83	37	108	265	175	30	1,5	22	370	240	0,87
FRB23	3/4" - 1"	36	104	87÷91	110÷115	70	83	37	108	365	275	30	1,5	22	370	350	0,92

FRB

RETURN FILTERS

FILTER ELEMENT

	A	B*	C	Kg	AREA (cm ²)	
					Media F+	MediaC+
ERB11	43	20	200	0,20	1.030	1.225
ERB21	59	28	134	0,30	1.140	1.430
ERB22	59	28	200	0,40	1.760	2.200
ERB23	59	28	300	0,50	2.380	3.400

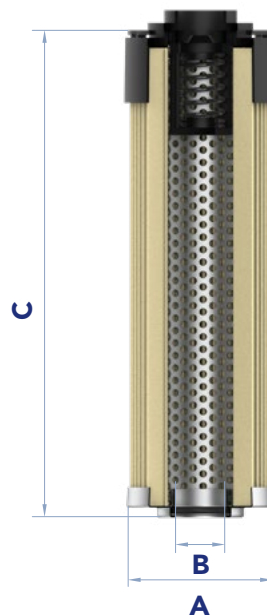

MAINTENANCE

- 1) Stop the system and verify there is no pressure in the filter.
- 2) Loosen the the cover (1) and remove the spring (2) below.
- 3) Remove the dirty filter element (3) using its handle.
N.B. The exhausted filter elements and the oil dirty filter parts are classified "Dangerous waste material" and must be disposed of according to the local laws, by authorized Companies.
- 5) Check the filter element part number on the filter label or in the ordering and option chart. Use only original spare parts.
- 6) Lubricate the element o-ring gasket (4) with oil.
- 7) Insert the clean element into its seat with care.
- 8) Re-assembly the spring (2).
- 9) Check the cover o-ring condition (6) and lubricate with oil.
If damaged, check the seal kit part number in the spare seal kit table.
- 10) Re-screw the cover (1).

Accessories:

Air breather filter element (7). If necessary, unscrew the cover (6) and replace the air breather element with a new one (please contact our Customer Service for additional information).

Clogging indicator (8).

If damaged, unscrew and replace it (check the part number in the ordering and option chart). Lubricate the o-ring gaskets with oil and tighten until it stops, with a tightening torque of 40 Nm +5/0.

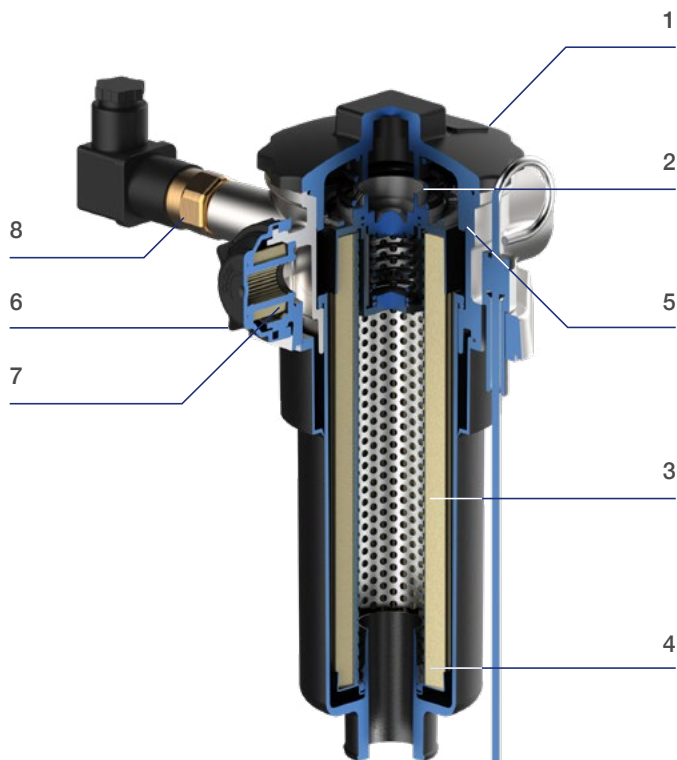



PRESSURE DROP CURVES (ΔP)

The “Assembly Pressure Drop (Δp)” is obtained by adding the pressure drop values of the Filter Housing and of the Clean Filter Element corresponding to the considered Flow Rate and it must

be lower than 50 kPa (0,5 bar). In any case this value should never exceed 1/3 of the bypass valve setting.

FILTER HOUSING PRESSURE DROP
(mainly depending on the port size)

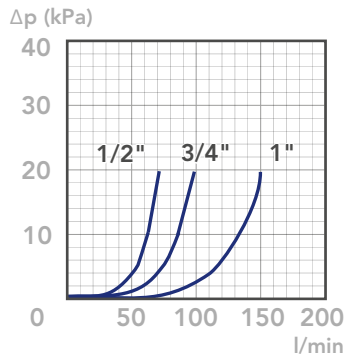

CLEAN FILTER ELEMENT PRESSURE DROP WITH F+ AND C+ MEDIA
(depending both on the internal diameter of the element and on the filter media)

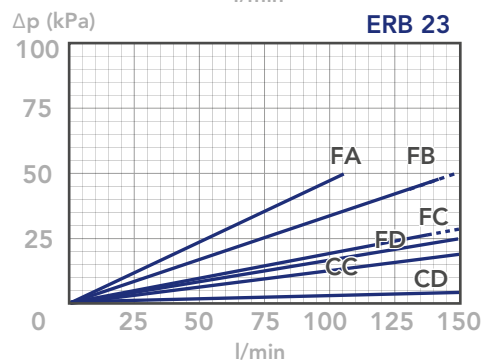
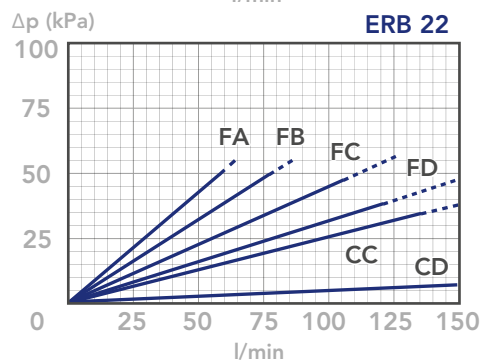
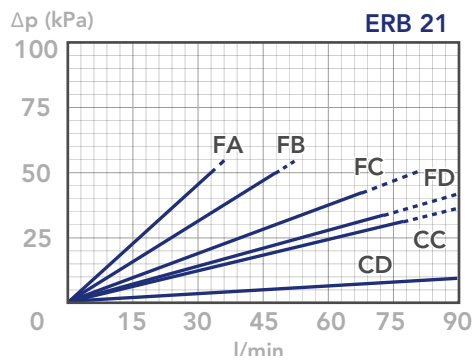
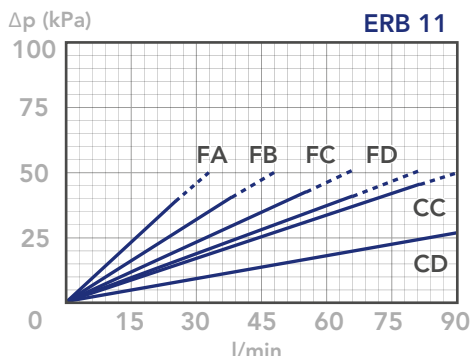

FRB

RETURN FILTERS

BYPASS VALVE PRESSURE DROP

When selecting the filter size, these curves must be taken into account if it is foreseen that any flow peak is to be absorbed by the bypass valve, it also must be of proper configuration to avoid pressure peaks. The valve pressure drop is directly proportional to fluid specific gravity.

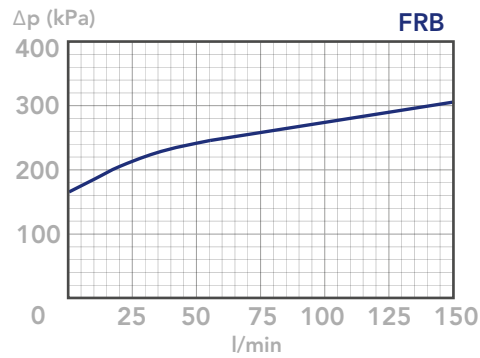

N.B.

All the curves have been obtained with mineral oil having a kinematic viscosity 30 cSt and specific gravity 0,86 kg/dm³; for fluids with different features, please consider the factors described in the first part of this catalogue. All the curves

are obtained from test done at the UFI FILTERS HYDRAULICS Laboratory, according to the specification ISO 3968. In case of discrepancy, please check the contamination level, viscosity and features of the fluid in use.