

TECHNOLOGY IN MOTION

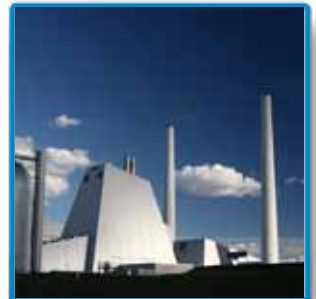

INDUSTRIAL



POWER GEN



WIND ENERGY

SMT Series

Dry & submersible screw pumps
for industrial applications - 80 bar pressure



Applications / Applicazioni

Options are indicatory for applications. Please, always contact **Settima** Technical dept. / *Le opzioni sono indicative per ogni applicazione. Prego controllare sempre con l'Ufficio Tecnico Settima.*

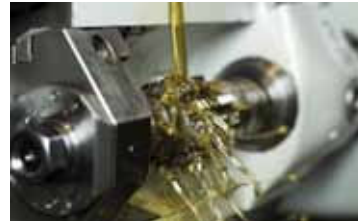

	High viscosity <i>Elevate viscosità</i>	Body material <i>Materiale corpo</i>	Screw material <i>Materiale viti</i>	Seals <i>Tenute</i>
Power units, Presses, Machine tools, PIMMs, Metal & Steel (coolant fluid, transfer and filtration), Hydraulic Power to Control the Governor, Wicket Gates, Hydro Propellers, Filtration & Oil transfer, Off-line filtration, Off-shore platforms, Process charge (feeding and boosting), Hydraulic braking systems, Oil jacking, Hydro power (turbines & compressors lubrication), Control oil service, Chemical metering, Cranes, Hydraulic pitch control, Yaw control	-	-/G	-/HA	-/TM
Chemical processing (dosing, transfer, high temperature and hazardous fluids), Sealing oil service for gas turbine	SN	G/GZ	HA/HD	TM/FGM
Paper & Pulp (rotating equipment lubrication) Lube oil (circulation & transfer), Turbine Shaft jacking, Rotor jacking, Ball Mill Gearbox lubrication, Gear box lubrication & filtration (high viscosity lube, air emulsion), Forced lubrication systems	SN	-	-	TM
Building & Construction (hydraulic lifts & elevators)	-	G	-	-
Mining (fuel oil transfer, bar mill lubrication)	-	G	*	*
Fuel unloading, Forwarding, Transfer and Feeding Burner operations service, Fuel service (boosting & transfer), Oil rigs, refineries (transport, meter and mix), Pipelines re-injection, Tank loading & unloading Process charge, Boiler injection	-	G/GZ	HA	TM
Oil filtration & Cooling systems	-	-	-	*
Tool machines high pressure coolant	-	G/GZ	HA	TMK

All data reported by this catalogue can change without any notice / *I dati presenti nel catalogo possono cambiare senza preavviso.*

*Standard configuration and material / *Configurazione e materiali standard.*

Technical characteristics / Caratteristiche tecniche

Types <i>Tipi</i>	Dry (SMT) or submerged (SMIT) <i>Esterno (SMT) o sommerso (SMIT)</i>	
Models / Modelli	20 – 25 – 32 – 40 – 45 – 55 – 60 – 70 – 80 – 90	
Installation <i>Installazione</i>	Free for SMT. Submerged (totally or partially) for SMIT <i>Qualsiasi per SMT. Sommersa (parzialmente o completamente) per SMIT</i>	
Flanges / Flange	ISO 3019/2	
Connections / Conessioni	SAE 3000 - BSPP	
Drive loading <i>Carichi</i>	No axial or radial loads <i>Nessun carico assiale o trasversale</i>	
Shaft rotation <i>Rotazione albero</i>	Clockwise (from shaft end) , (suitable also for counter clockwise rotation) <i>Destra (disponibile anche per rotazione sinistra)</i>	
Shaft speed <i>Velocità di rotazione</i>	From 500 to 3.600 rpm ⁽¹⁾ <i>Da 500 a 3.600 rpm⁽¹⁾</i>	
Flows <i>Portate</i>	From 4 up to 1.220 L/min <i>Da 4 a 1.220 L/min</i>	
Outlet Pressure <i>Pressione di mandata</i>	Up to 80 bar <i>Fino a 80 bar</i>	
Inlet Pressure <i>Pressione in aspirazione</i>	Min. -0.7 bar max. 3 bar ⁽²⁾ <i>Min. -0.7 bar max. 3 bar⁽²⁾</i>	
Fluids ⁽³⁾ <i>Fluidi⁽³⁾</i>	<ul style="list-style-type: none"> • Mineral oil HLP e HVLP • Ecologic fluids HETG, HEPG, HEE • Synthetic fluid or emulsion: HFA oil-water emulsion, HFB water-oil emulsion 40% of volume, HFC water/glycole – water max 35 to 55%, HFDR phosphate ester • Lubrication high viscosity oils • Special synthetic fluid: MIL-H, SKYDROL, • Fuel oil: MGO, MDO, Low sulfur MDO and HFO • DMX (ISO8217), DMA, DMB, DMC, DMZ • Bunker oil, furnace oil, engines oil, heating oil, hydraulics oils DIN 51524 	<ul style="list-style-type: none"> • Oli minerali HLP e HVLP • Fluidi ecologici HETG, HEPG, HEE • Fluidi sintetici o emulsioni: HFA emulsione olio-acqua, HFB emulsione acqua-olio 40% dl volume, HFC acqua/glicole – acqua max 35 to 55%, HFDR phosphate ester • Olio ad alta viscosità per lubrificazione • Fluidi speciali sintetici: MIL-H, SKYDROL, • Fuel oil: MGO, MDO, Basso livello di zolfo MDO e HFO • DMX (ISO8217), DMA, DMB, DMC, DMZ • Bunker oil, furnace oil, olio per motori, heating oil, olio idraulico DIN 51524
Viscosity <i>Viscosità</i>	From 1 up to 100.000 cSt ⁽⁴⁾ <i>Da 1 fino a 100.000 cSt⁽⁴⁾</i>	
Seals polymer (shaft, O-ring) <i>Polimero guarnizioni (albero, anello di tenuta)</i>	NBR, FKM, EPDM ⁽⁵⁾	
Seal type <i>Tipo di tenuta</i>	TM, TMK, TMZ, FGM	
Acoustic Emissions <i>Emissioni Acustiche</i>	From 52 up to 68 db(A) at 2.950 rpm (value based on ISO 4412 test procedure) <i>Da 52 fino a 68 db(A) a 2.950 rpm (ISO 4412 test)</i>	
Pump body <i>Corpo pompa</i>	Extruded aluminum alloy <i>Alluminio estruso</i>	
Pump body (special applications) <i>Corpo pompa (applicazioni speciali)</i>	Cast iron, carbon steel. <i>Ghisa, acciaio.</i>	
Screws <i>Viti</i>	Steel for main screw , idler cast iron <i>Acciaio vite principale, ghisa viti secondarie</i>	
Screws (special applications) <i>Viti (applicazioni speciali)</i>	Core hardened steel screws, surface treated screws <i>Viti in acciaio temprato, viti trattate superficialmente</i>	
Environment temperature <i>Temperatura ambiente</i>	From -50° up to +60°C <i>Da -50° a +60°C</i>	
Hydraulic Temperature <i>Temperatura olio</i>	From -50°C up to +300°C <i>Da -50°C a +300°C</i>	
Filtration <i>Filtrazione</i>	Permissible degree of fluid contamination NAS to 1638 class 10 or ISO DIS 4406 – 19/16. Recommended filtration $\beta_{25} \geq 75$ <i>Contaminazione NAS tipo 1638 classe 10 o ISO DIS 4406 – 19/16 . Filtrazione raccomandata $\beta_{25} \geq 75$</i>	

All data reported by catalogue can change without any notice. *I dati presenti nel catalogo possono cambiare senza preavviso.*

(1) For shaft speed lower than 1.000 rpm and over 1.800 rpm please contact Settima. *Per velocità inferiori a 1.000 rpm e maggiori di 1.800 rpm contattare Settima.*

(2) For higher pressure please contact Settima. *Per pressioni maggiori contattare Settima*

(3) For request of different fluids please contact Settima. *Per l'utilizzo di diversi fluidi contattare Settima.*

(4) For level of viscosity lower than 20 cSt and over 320 cSt please contact Settima. *Per livelli di viscosità inferiori a 20 cSt e superiori a 320 cSt contattare Settima.*

(5) For special seals, contact Settima. *Per tenute speciali, contattare Settima.*

Product description / Descrizione prodotto

Exploded drawing / Disegno esploso

Front flange and suction ports configurations / Configurazione flange e porte di aspirazione

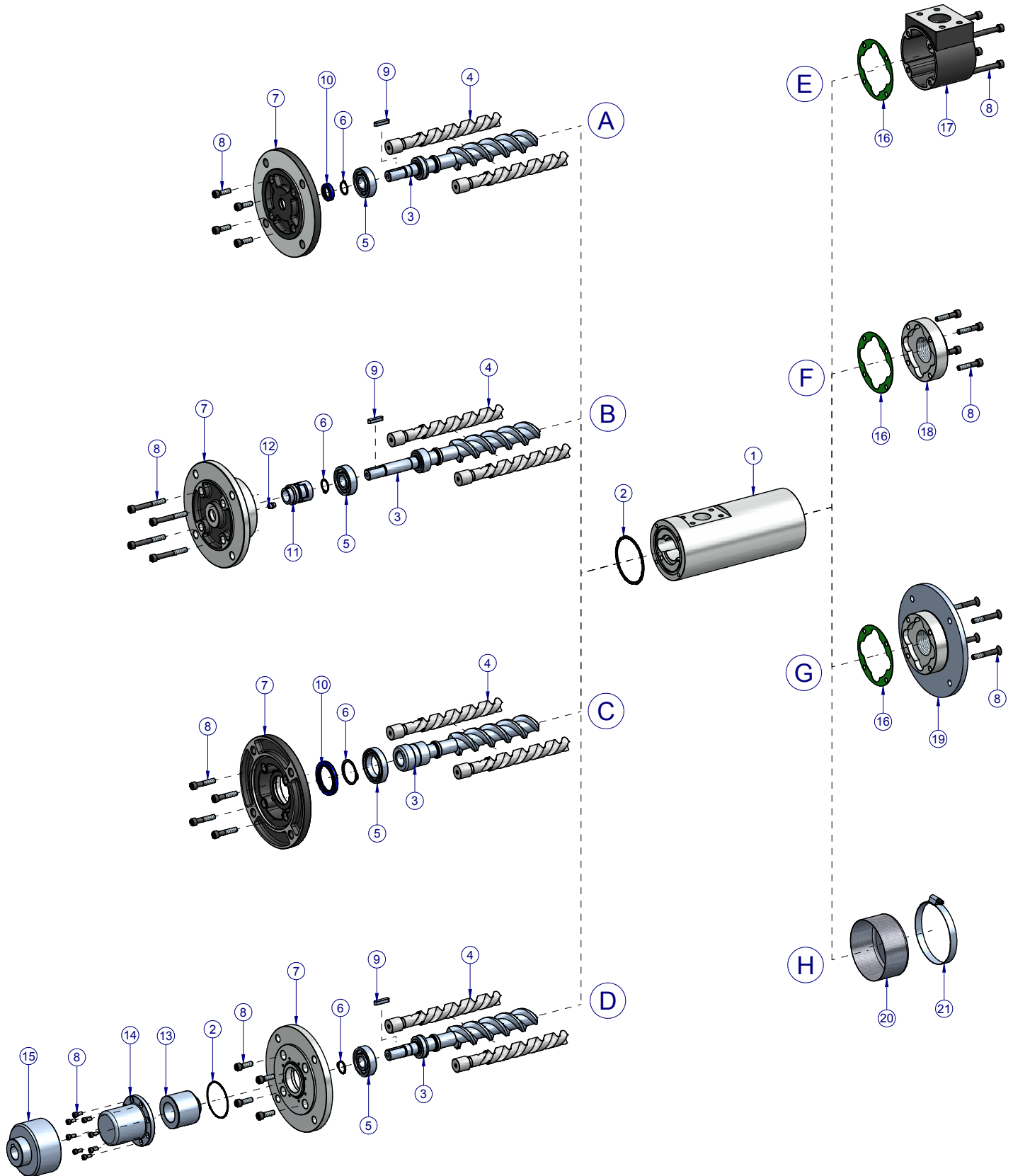

Product description / Descrizione prodotto

N°	PARTS DESCRIPTION / DESCRIZIONE COMPONENTI	
1	Pump body / Corpo pompa	Common components
2	O-ring / Anello O-ring	Common components
3	Main screw / Vite centrale	Common components
4	Idler screw / Vite laterale	Common components
5	Ball bearing / Cuscinetto	Common components
6	Seeger	Common components
8	Screw / Vite	Common components
SHAFT AND SEAL OPTIONS / OPZIONI ALBERI E TENUTE		
A	SMT LIP SEAL / SMT TENUTA A LABBRO	
9	Key / Linguetta	Common components
10	Seal / Anello di tenuta	Common components
7	Flange / Flangia	Common components
B	SMT MECHANICAL SEAL - TM OPTION / SMT TENUTA MECCANICA - OPZIONE TM	
9	Key / Linguetta	Common components
11	Mechanical seal / Tenuta meccanica	Common components
12	Driving oil bushing / Boccola convoglia olio	Common components
7	Flange / Flangia	Common components
C	SMT HOLLOW SHAFT (LIP SEAL) - AC OPTION / SMT ALBERO CAVO (TENUTA A LABBRO) - OPZIONE AC	
10	Seal / Anello di tenuta	Common components
7	Flange / Flangia anteriore	Common components
D	SMT MAGNETIC COUPLING - FGM OPTION / SMT GIUNTO MAGNETICO - OPZIONE FGM	
9	Key / Linguetta	Common components
7	Flange / Flangia	Common components
2	O-ring / Anello O-ring	Common components
13	Internal rotor MC / Rotore interno MC	Common components
14	Containment shroud MC / Cappuccio MC	Common components
15	External rotor MC / Rotore esterno MC	Common components
SUCTION PORTS OPTIONS / OPZIONI PORTE DI ASPIRAZIONE		
E	SMT RADIAL SUCTION COVER / SMT TAPPA RADIALE	
16	Plane gasket / Guarnizione piana	Common components
17	Radial suction cover / Tappa radiale	Common components
F	SMT AXIAL BSPP - AX OPTION / SMT ASSIALE BSPP - OPZIONE AX	
16	Plane gasket / Guarnizione piana	Common components
18	Axial suction cover / Tappa assiale	Common components
G	SMT TOP FLANGE FOR VERTICAL INSTALLATION OVER TANK - AL OPTION / SMT TAPPA ASPIRAZIONE PER INSTALLAZIONE VERTICALE SOPRA SERBATOIO - OPZIONE AL	
16	Plane gasket / Guarnizione piana	Common components
19	Tank top flange / Tappa aspirazione sopra serbatoio	Common components
H	SMIT SUBMERSIBLE / SMIT SOMMERSA	
20	Filter / Filtro	Common components
21	Clamp / Fascetta	Common components

SMT pump - Dimensional drawings / Disegni dimensionali

SMT Pump



SMT Series / Serie SMT
Dry screw pump
Pompa per uso esterno

SMIT Pump



SMIT Series / Serie SMIT
Submersible screw pump
Pompa per uso sommerso

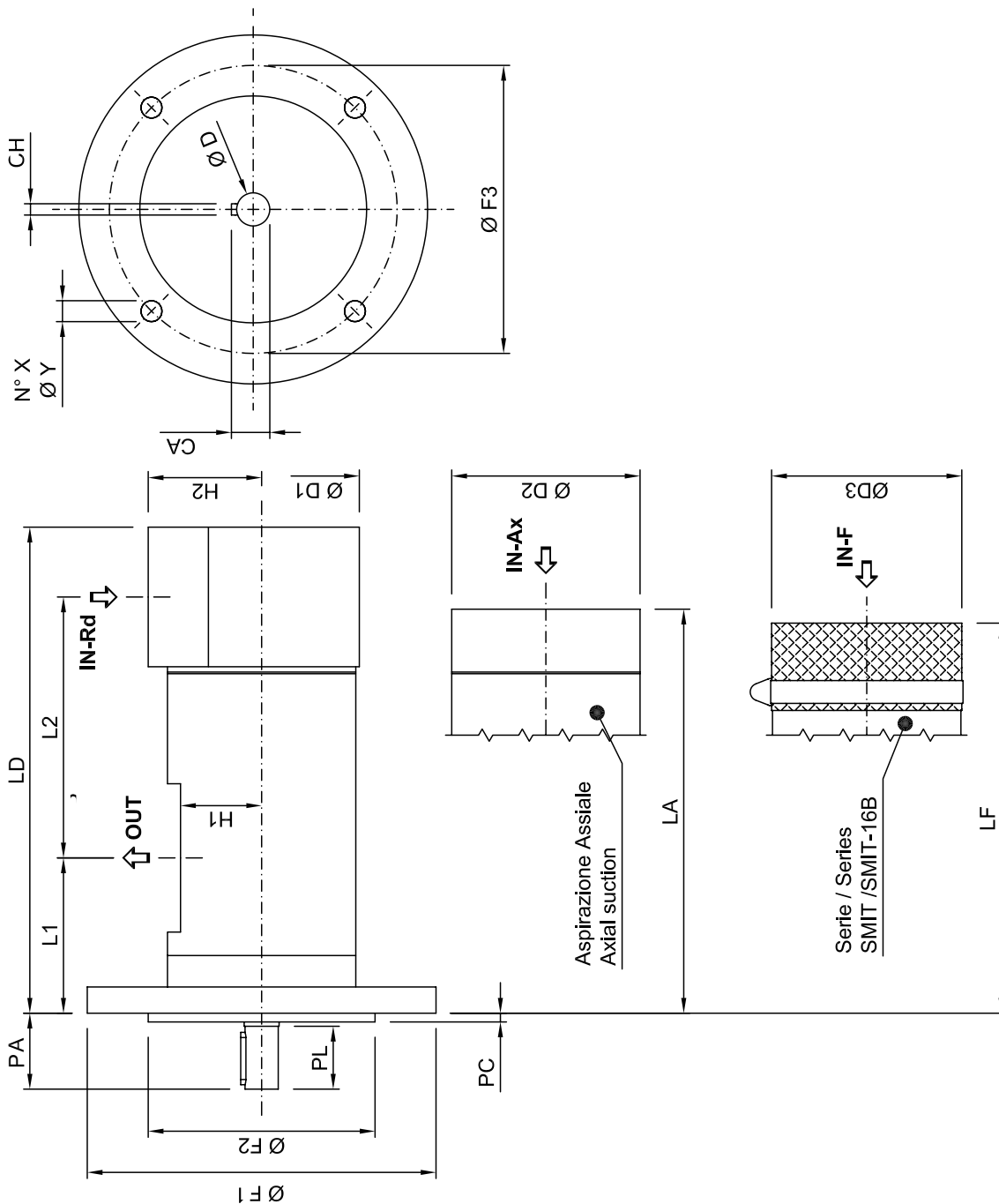

SMT pump - Dimensional drawings / Disegni dimensionali

SMT	Dry screw pump / Pompa per uso esterno	SMT		Submersible screw pump/Pompa per uso sommerso	SMT																	
		Flange Flangia				Shaft Albero			Suction Aspirazione		Discharge Mandata		Pump Pompa									
Type/Tipo	ØF2	ØY	ØF3	ØF1	PL	ØD	CA	CH	IN-Rd	IN-Ax	H2	OUT	H1	PA	ØD1	ØD2	L1	L2	LD	LA	Kg	LF
GR20 SMT 8L-12L-15L-20L- 23L	80.0	11.0	103.0	125.0	30.0	14.0	16.0	5.0	1/2" BSPP	1/2" BSPP	26.0	1/2" BSPP	25.0	37.0	59.0	59.0	53.0	118.5	193.0	174.0	1.5	173.0
GR25 SMT 25L-30L	80.0	11.0	103.0	125.0	36.0	19.0	21.5	6.0	3/4" BSPP	3/4" BSPP	27.0	1/2" BSPP	27.5	42.0	65.0	65.0	72.5	171.0	262.0	262.0	4	242.5
GR32 SMT 35L-45L-55L- 75L	100.0	11.0	125.0	150.0	35.0	19.0	21.5	6.0	1"1/4 SAE- 3000	1"1/4 BSPP	55.0	1" SAE- 3000	41.0	41.0	96.0	94.0	69.0	192.0	295.0	248.0	6.5	239.0
GR40 SMT 100L-125L-150L	125.0	14.0	160.0	188.0	34.0	19.0	21.5	6.0	1"1/2 SAE- 3000	1"1/2 BSPP	65.0	1"1/4 SAE- 3000	46.5	39.5	112.0	108.0	84.5	224.5	348.0	302.0	10.8	294.0
GR45 SMT 180L-210L	125.0	14.0	160.0	188.0	55.0	32.0	35.0	10.0	2" SAE- 3000	2" BSPP	85.0	1"1/2 SAE- 3000	51.5	64.5	125.0	122.5	89.0	248.0	382.0	330.0	15	312.0
GR55 SMT 250L-300L- 330L-380L	160.0	18.0	200.0	235.0	55.0	32.0	35.0	10.0	2"1/2 SAE- 3000	2"1/2 BSPP	95.0	2" SAE- 3000	55.0	61.5	148.0	142.5	100.5	297.0	449.5	385.5	23.5	395.5
GR60 SMT 440L-500L	160.0	18.0	200.0	235.0	55.0	32.0	35.0	10.0	3" SAE- 3000	3" BSPP	105.0	2"1/2 SAE- 3000	63.0	65.5	160.0	155.0	101.0	342.0	505.5	423.5	30	430.5
GR70 SMT 600L-660L-800L	200.0	22.0	250.0	300.0	55.0	32.0	35.0	10.0	3"1/2 SAE- 3000	3"1/2 BSPP	110.0	3" SAE- 3000	73.0	60.5	180.0	180.0	115.5	422.0	605.5	529.5	44	543.5
GR80 SMT 1.000L-1.200L	200.0	22.0	250.0	300.0	60.0	38.0	41.0	10.0	4" SAE- 3000	4" BSPP	125.0	3" SAE- 3000	83.0	75.0	210.0	210.0	150.0	470.5	695.0	644.0	59	628.0
GR90 SMT 1.220L	200.0	22.0	250.0	300.0	60.0	38.0	41.0	10.0	4" SAE- 3000	4" BSPP	125.0	3" SAE- 3000	83.0	75.0	210.0	210.0	150.0	470.5	695.0	644.0	61	628.0

All data reported by catalogue can change without any notice. I dati presenti nel catalogo possono cambiare senza preavviso.

SMT AC pumps - Dimensional drawings / Disegni dimensionali

SMT AC Pump



SMT AC Series / Serie SMT AC
Dry screw pump
Pompa per uso esterno

SMIT AC Pump



SMIT AC Series / Serie SMIT AC
Submersible screw pump
Pompa per uso sommerso

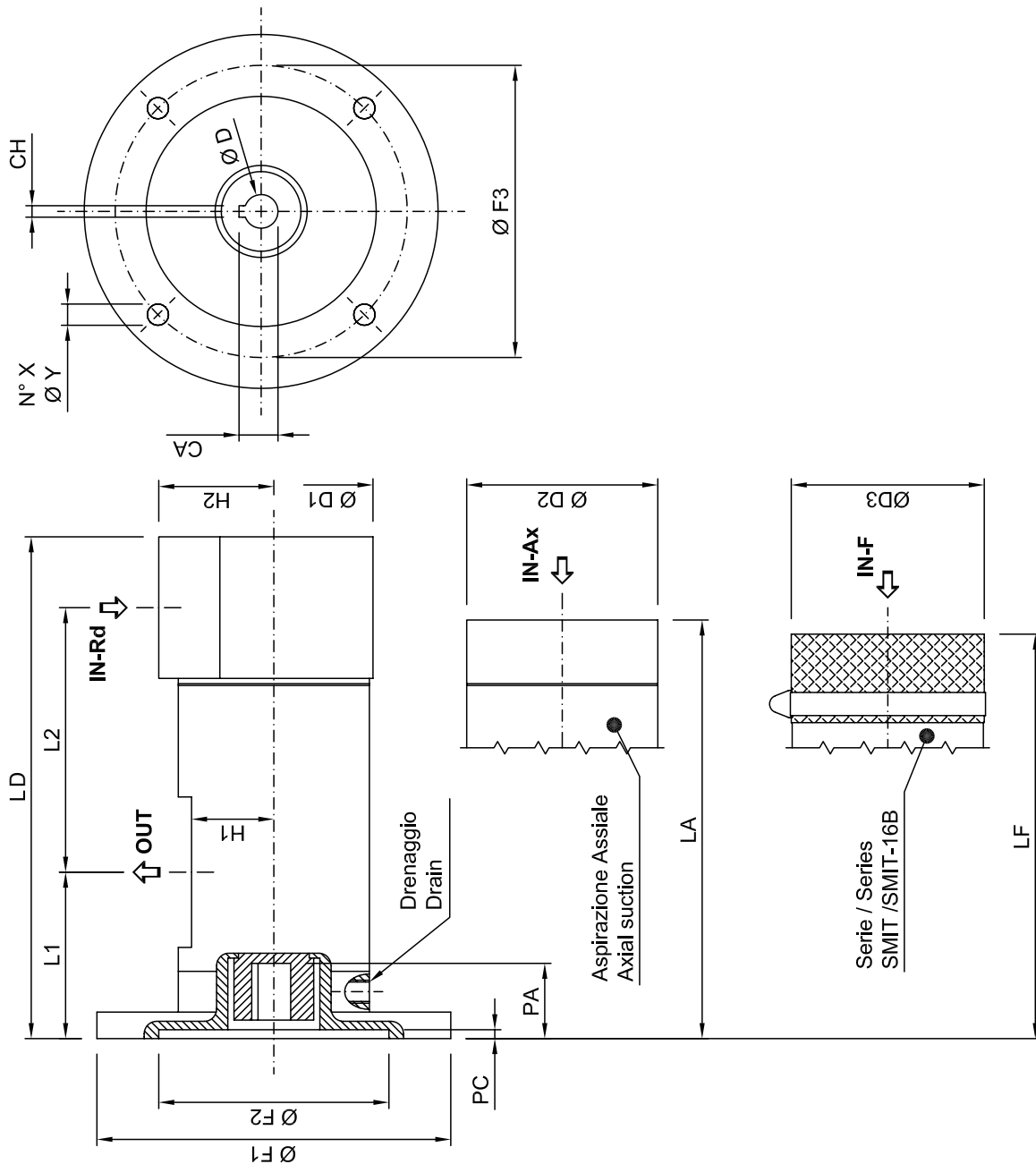

SMT AC pumps - Dimensional drawings / Disegni dimensionali

SMT AC

Dry screw pump /
Pompa per uso esterno





SMT AC

Submersible
screw pump/
Pompa per
uso som-
merso

Type/Typo	Flange/Flangia			Shaft / Albero			Suction / Aspirazione			Discharge / Mandata		Pump / Pompa									
	ØF2	ØY	ØF3	ØD	CA	CH	IN-Rd	IN-Ax	H2	OUT	H1	PA	ØD1	ØD2	L1	L2	LD	LA	KG	ØD3	LF
GR20 SMT AC11 B5 8-12-15-20-23	95.0	9.0	115.0	140.0	11.0	4.2	1/2"BSPP	1/2"BSPP	26.0	1/2"BSPP	25.0	25.0	59.0	59.0	57.0	118.5	197.0	178.0	1.5	60.0	177.0
GR20 SMT AC14 B5 8-12-15-20-23	110.0	9.5	130.0	160.0	14.0	5.2	1/2"BSPP	1/2"BSPP	26.0	1/2"BSPP	25.0	33.5	59.0	59.0	56.0	118.5	196.0	177.0	1.5	60.0	176.0
GR20 SMT AC19 B5 8-12-15-20-23	130.0	11.0	165.0	200.0	19.0	6.5	1/2"BSPP	1/2"BSPP	26.0	1/2"BSPP	25.0	42.0	59.0	59.0	75.0	118.5	215.0	196.0	1.5	60.0	195.0
GR25 SMT AC14 B5 25-30	110.0	9.5	130.0	160.0	14.0	5.2	3/4"BSPP	3/4"BSPP	27.0	1/2"BSPP	27.5	32.5	65.0	65.0	73.5	171.0	263.0	263.0	2.7	66.0	243.5
GR25 SMT AC19 B5 25-30	130.0	10.5	165.0	200.0	19.0	6.5	3/4"BSPP	3/4"BSPP	27.0	1/2"BSPP	27.5	42.5	65.0	65.0	76.5	171.0	266.0	266.0	2.7	66.0	246.5
GR32 SMT AC19 B5 35-45-55-75	130.0	12.0	165.0	200.0	19.0	6.5	1"1/4SAE-3000	1"1/4BSPP	55.0	1"1/4BSPP	41.0	43.7	96.0	94.0	92.7	192.0	318.7	271.7	4.4	95.0	262.7
GR32 SMT AC24 B5 35-45-55-75	130.0	12.0	165.0	200.0	24.0	8.5	1"1/4SAE-3000	1"1/4BSPP	55.0	1"1/4BSPP	41.0	52.7	96.0	94.0	92.7	192.0	318.7	271.7	4.4	95.0	262.7
GR40 SMT AC19 B5 100-125-150	130.0	12.0	165.0	200.0	19.0	6.5	1"1/2SAE-3000	1"1/2BSPP	65.0	1"1/2BSPP	46.5	42.5	112.0	108.0	109.5	224.5	373.0	327.0	7	109.0	319.0
GR40 SMT AC24 B5 100-125-150	130.0	12.0	165.0	200.0	24.0	8.5	1"1/2SAE-3000	1"1/2BSPP	65.0	1"1/2BSPP	46.5	52.5	112.0	108.0	109.5	224.5	373.0	327.0	7	109.0	319.0
GR40 SMT AC28 B5 100-125-150	180.0	14.0	215.0	250.0	28.0	8.5	1"1/2SAE-3000	1"1/2BSPP	65.0	1"1/2BSPP	46.5	64.0	112.0	108.0	120.0	224.5	383.5	337.5	7	109.0	329.5
GR45 SMT AC28 B5 180-210	180.0	14.0	215.0	250.0	28.0	8.5	2"SAE-3000	2"BSPP	85.0	1"1/2SAE-3000	51.5	63.5	125.0	122.5	120.0	248.0	413	361.0	7	123.5	343.0
GR45 SMT AC38 B5 180-210	230.0	15.0	265.0	300.0	38.0	10.5	2"SAE-3000	2"BSPP	85.0	1"1/2SAE-3000	51.5	81.0	125.0	122.5	133.5	248.0	426.5	374.5	7	123.5	356.5
GR55 SMT AC28 B5 250-300-330-380	180.0	14.0	215.0	250.0	28.0	8.5	2"1/2SAE-3000	2"1/2BSPP	95.0	2"SAE-3000	55.0	62.5	148.0	142.5	125.5	297.0	474.5	410.5	15.5	143.5	420.5
GR55 SMT AC38 B5 250-300-330-380	230.0	15.0	265.0	300.0	38.0	10.5	2"1/2SAE-3000	2"1/2BSPP	95.0	2"SAE-3000	55.0	82.5	148.0	142.5	145.5	297.0	494.5	430.5	15.5	143.5	440.5
GR60 SMT AC28 B5 440-500	180.0	14.0	215.0	250.0	28.0	8.5	3"SAE-3000	3"BSPP	105.0	2"1/2SAE-3000	63.0	65.0	160.0	155.0	126.0	342.0	530.5	448.5	25	154.0	455.5
GR60 SMT AC38 B5 440-500	230.0	14.5	265.0	300.0	38.0	10.5	3"SAE-3000	3"BSPP	105.0	2"1/2SAE-3000	63.0	83.0	160.0	155.0	146.0	342.0	550.5	468.5	25	154.0	475.5
GR70 SMT AC28 B5 600-660-800	180.0	14.0	215.0	250.0	28.0	8.5	3"1/2SAE-3000	3"1/2BSPP	110.0	3"SAE-3000	73.0	63.1	180.0	180.0	139.3	422.0	553.3	553.3	30	179.0	567.3
GR70 SMT AC38 B5 600-660-800	230.0	14.5	265.0	300.0	38.0	10.5	3"1/2SAE-3000	3"1/2BSPP	110.0	3"SAE-3000	73.0	87.3	180.0	180.0	160.5	422.0	574.5	574.5	30	179.0	588.5

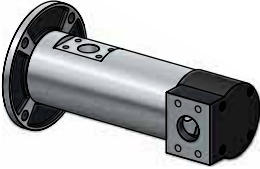
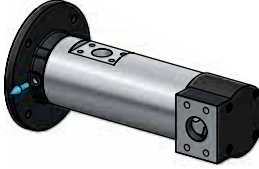
All data reported by catalogue can change without any notice. I dati presenti nel catalogo possono cambiare senza preavviso.

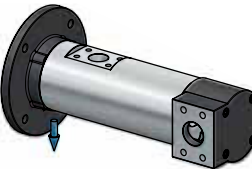
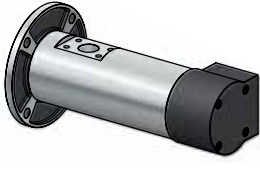
Suction and drain hole configuration table / Tabella configurazioni porte di aspirazione e drenaggio

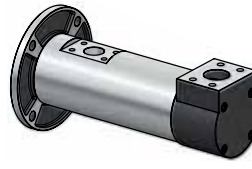
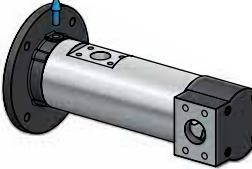
SUCTION CONFIGURATION CODES CODICI CONFIGURAZIONE ASPIRAZIONE	DRAIN CONFIGURATION CODES CODICI CONFIGURAZIONE DRENAGGIO
 T1	 D1
 T2	 D2
 T3	 D3
 T4	 D4

Standard configuration / Configurazione standard: **T1 – D2**

Standard configuration for pumps **WITH RP VALVE*** / Configurazione standard per pompa **CON VALVOLA RP***: **T4 – D2**

Example of code for optional suction and drain configuration / Esempio di codice per aspirazione e drenaggio non standard:

GR32 SMT 45L T1 D3 ✓



* Settima recommends that in case of request of pump with RP valve (external variable regulation valve), it is necessary to choose very carefully the suction and drain configuration. Once the external valve is built on the pump it will be not possible any change of both configurations.

Please, check the following page for RP option. / Settima raccomanda di scegliere attentamente la configurazione delle porte nel caso di pompa con valvola RP (valvola regolazione variabile esterna). La valvola RP impedisce di modificare l'orientamento delle porte una volta installata sulla pompa.

Vedere pagina seguente per l'opzione RP.

Product configuration / Configurazione prodotto

RP relief valve option configuration table / Tabella configurazioni valvola di sicurezza RP

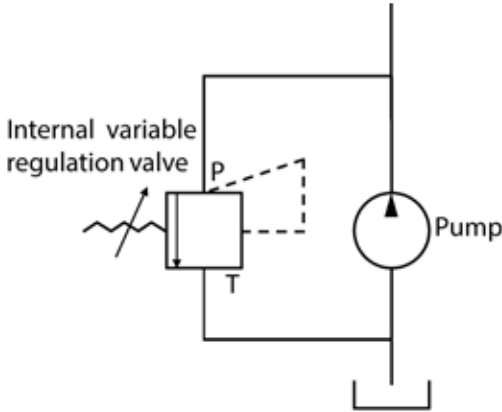
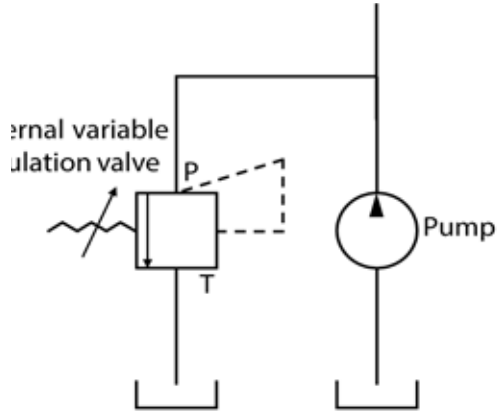
INTERNAL BYPASS BYPASS INTERNO	EXTERNAL BYPASS BYPASS ESTERNO
	
	

Internal Bypass variable regulation valve is available as option for the following models: GR20, GR25, GR32, GR40, GR45, GR55, GR60, GR70 / *Valvola a regolazione variabile con **bypass interno** opzione disponibile per i modelli GR20, GR25, GR32, GR40, GR45, GR55, GR60, GR70*

External Bypass variable regulation valve is available as option for the following models: GR80, GR90 / *Valvola a regolazione variabile con **bypass esterno** opzione disponibile per i modelli GR80, GR90.*

Example of code for optional RP valve / *Esempio di codice per opzione RP:*

GR32 SMT 45L T4 D2 RP

Product configuration / Configurazione prodotto

Motor pump selection table / Tabella selezione motore

Size	Motor form <i>Forma motore</i>	56 AC9	63 AC11	71 AC14	80 AC19	90 AC24	100 AC28	112 AC28	132 AC38
GR 20	B14	✓	✓	✓	✓				
	B5		✓	✓	✓				
GR 25	B14			✓	✓				
	B5			✓	✓				
GR 32	B14				✓	✓			
	B5				✓	✓			
GR40	B14				✓	✓	✓	✓	
	B5				✓	✓	✓	✓	
GR45	B5						✓	✓	✓
GR55	B5						✓	✓	✓
GR60	B5						✓	✓	✓
GR70	B5						✓	✓	✓

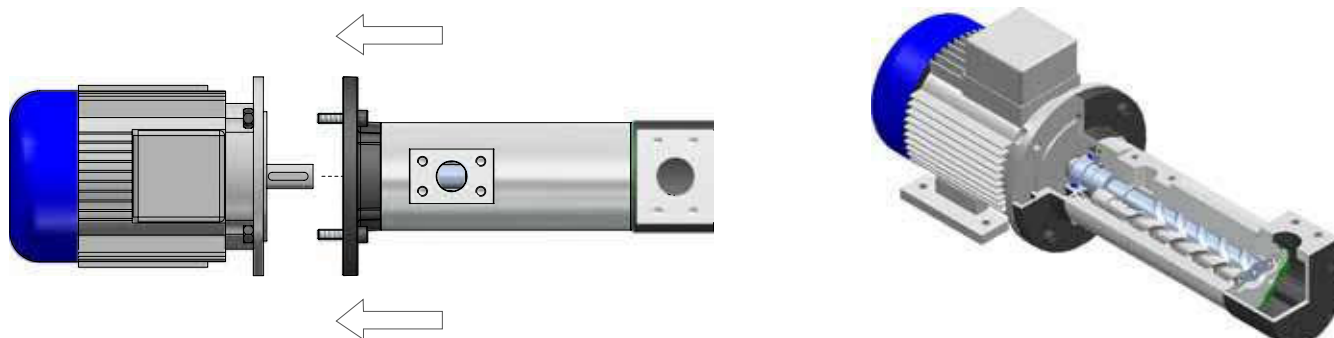

Example of codes for hollow shaft models / Esempi di codici per modelli ad albero cavo:

GR32 SMT 45L AC24/B5 ✓

Ordering code table / Tabella codici di ordinazione

Pump type Tipo	Pump model Modello	Nominal flow Portata nominale	High viscosity flag Alta viscosità	Shaft type Tipo albero	Hollow shaft flange Flangia albero cavo	Pump body** Corpo pompa**	Seals polymer (shaft, O-ring) Polimero guarnizioni (albero, anello di tenuta)	Screw treatment Trattamento viti	Seal type Tipo di tenuta	Suction configuration code Codice porta aspirazione	Drain configuration codes (hollow shaft only) Codici drenaggio (solo AC)	Internal pressure relief valve Valvola interna di sicurezza	Suction flange Flangia d'aspirazione	Rotation Rotazione	Bearing type Tipo cuscinetto
GR20		8L, 12L, 15L, 20L, 23L		Standard normal shaft & flange type albero maschio e flangia (none)		Standard aluminium (none)		Standard steel main screw cast iron idler screws vite centrale in acciaio viti laterali in ghisa (none)	Standard Lip seal (none)	Standard T1 (none)	Standard D2 (none)	Standard No security valve Nessuna valvola (none)	Standard radial radiale (none)	Standard Clockwise destra (none)	Standard (none)
		25L, 30L													
GR25		35L, 45L, 55L, 75L													
		100L, 125L, 150L													
GR32		180L, 210L			B5 B14 (only hollow shaft) (solo albero cavo)	Optional GD cast iron ghisa	Standard NBR (none)	Optional HA*** core hardened steel screws (available only with mechanical seal)	Optional TM*** mechanical seal for oil	Standard T1 (none)	Standard D2 (none)	Optional RF1 5 bar security sicurezza 5 bar	Optional AXS axial SAE assiale SAE	Standard Clockwise destra (none)	Standard (none)
		250L, 300L, 330L, 380L													
GR40	SMT dry esterna	440L, 500L		Optional hollow shaft type* Albero cavo* AC9 AC11 AC14 AC19 AC24 AC28 AC38		Optional A carbon steel acciaio	Optional V FKM	Optional core hardened steel screws (available only with mechanical seal) viti in acciaio temprato (solo con TM)	Optional TMZ mechanical seal for fuel oil	Optional T2	Optional D1	Optional RF2 10 bar security sicurezza 10 bar	Optional AX axial SAE assiale SAE	Optional Clockwise sinistra	Optional CS encapsulated ball bearing cuscinetto schermato
		600L, 660L, 800L													
GR45	SMT submersible sommersa	1.000L, 1.200L				Optional AZ carbon steel with internal coating acciaio con rivestimento interno	Optional E EPDM	Optional HD surface treated screws viti trattate superficialmente	Optional FGM magnetic sealless pump	Optional T3	Optional D3	Optional RF3 15 bar security sicurezza 15 bar	Optional AL tank-top flange sopra serbatoio	Optional Counter clockwise	Optional Encapsulated ball bearing cuscinetto schermato
		1.220L													
GR55															
GR60															
GR70															
GR80															
GR90															

* To request the right hollow shaft according to the pump model please check chapter "Motor pump selection". Per richiedere il giusto tipo di albero cavo in base al modello di pompa vedere il capitolo "Selezione motore".

** Please contact Settima for different available materials and treatments. Contattare Settima per differenti materiali e trattamenti disponibili.

*** Options HA and TM are not available for version SMT AC. Le opzioni HA e TM non sono disponibili per i modelli SMT AC.

**** RP valve is not available with options AX and AL. La valvola RP non è disponibile con le opzioni AX e AL.

Settima three screw pumps / Le pompe a tre viti Settima

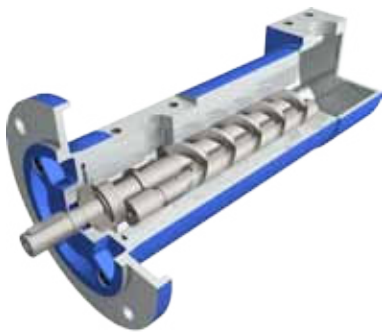

Three screw pumps represent the largest class of multiple screw pumps in service today. Well known to be very reliable, cost-efficient, virtually pulsation-free, very low noise, three screw pumps are considered as the most flexible pumps on the market.

No matter the applications and the environmental conditions, they are extensively used in meeting the requirements of all industrial sectors, from oil&gas, chemical, marine, industrial, mobile, energy and power generation, food processing, pulp & paper, pharmaceutical and many other. **Settima SMT** represent one of the most used three screw pumpseries all over the world after thirty five years of expericnece in the hydraulic sector.

No pulsation, smooth flow, low noise

SMT three screw pumps are designed to avoid any pulsation, to ensure a smooth operation and to reduce to the lowest level the acoustic emissions, eliminating all costs of second noise reduction measures.

The pulsation-free flow of **SMT** pumps allows Settima screw pumps also in output condition management critical to applications, such as precision hydraulic controls and fuel metering.

Magnetic coupling totally leakage free seal less pumps - FGM Option

SMT can be equipped with a magnetic coupling optionally. The hermetically sealed magnetic coupling is a permanent rotor magnetic synchronous coupling able to transmit torque through magnetic forces between the internal and the external rotor. Applying a magnetic coupling, the drive and the driven sides are hermetically separated.

In case of critical media handling, the magnetic coupling is a reliable seal and avoids any serious leaking. Due to the absence of mechanical connection, the vibrations due to torque transmission are very low, with completely leak-proof separation of the pumped fluid and the atmosphere. The magnetic coupling is used to ensure no media leaking or when working in environments with potentially explosive atmospheres.

Le pompe a tre viti, oggi, rappresentano la classe di pompe a viti maggiormente utilizzate e le più flessibili sul mercato. Sono considerate le più affidabili ed economiche e raggiungono bassissimi livelli di emissioni acustiche e di vibrazioni. Indipendentemente dal tipo di applicazione e dalle condizioni ambientali, sono ampiamente utilizzate in quanto rispettano i requisiti di tutti i settori industriali, dall'oil&gas, al settore chimico, navale, industriale, al settore della movimentazione, energetica, power generation, industrial alimentare, della carta, industria farmaceutica e molte altre. **Le pompe Settima SMT**, sono tra le più usate in tutto il mondo e vantano trentacinque anni di esperienza nel mondo dell'oleodinamica.

Flusso omogeneo, nessuna pulsazione, basse emissioni acustiche

Le pompe a tre viti della serie SMT sono progettate per eliminare le pulsazioni, assicurare un funzionamento omogeneo e ridurre al minimo le emissioni acustiche, eliminando di conseguenza i costi legati alla necessità di ricorrere a misure secondarie per la riduzione del rumore.

Il flusso privo di pulsazioni delle pompe **Settima SMT** ne permette l'applicazione anche in condizioni critiche, come ad esempio idraulica di precisione, dosaggio e misurazione di carburanti.

Giunto magnetico senza tenute rotanti, totale assenza di perdite - Opzione FGM

Le pompe Settima SMT possono, su richiesta, essere dotate di giunto magnetico. Con l'applicazione del giunto magnetico, l'elemento di trasmissione e quello condotto sono ermeticamente separati. In caso di fluidi pericolosi, l'utilizzo del giunto magnetico garantisce una tenuta affidabile che impedisce la possibilità di perdite. Il giunto magnetico consiste nella copertura fissata sull'elemento condotto che separa il rotore interno da quello esterno. Grazie all'assenza di connessioni meccaniche, le vibrazioni dovute alla trasmissione di potenza sono ridotte, senza possibilità di contaminazione dell'atmosfera da parte del fluido.

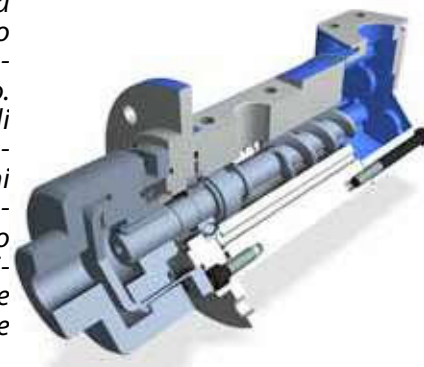

Performances @ 1500 - GR 20-25

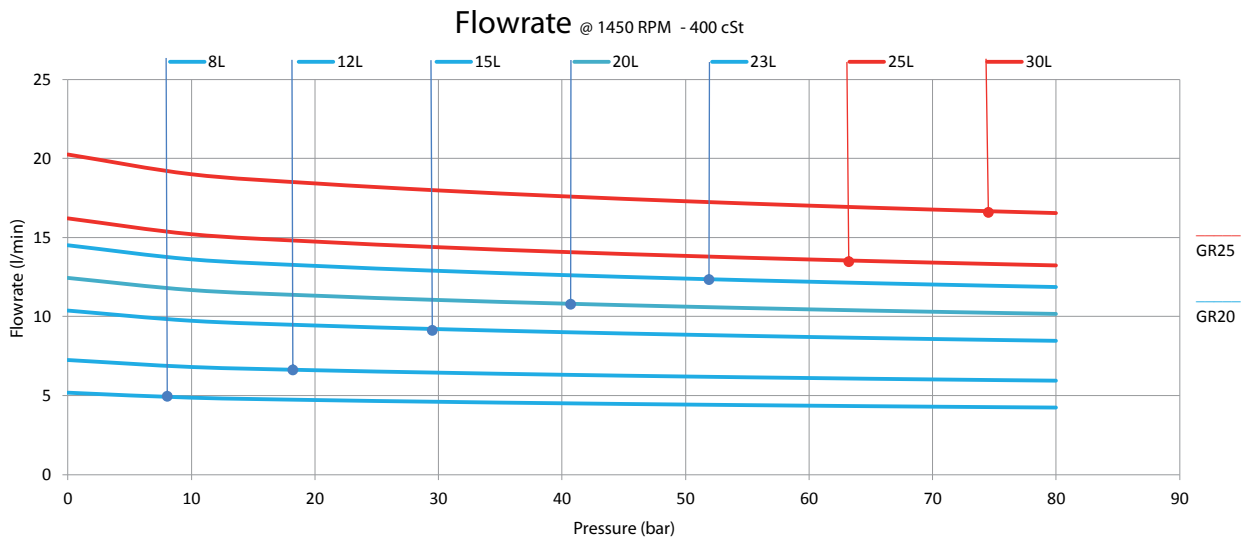
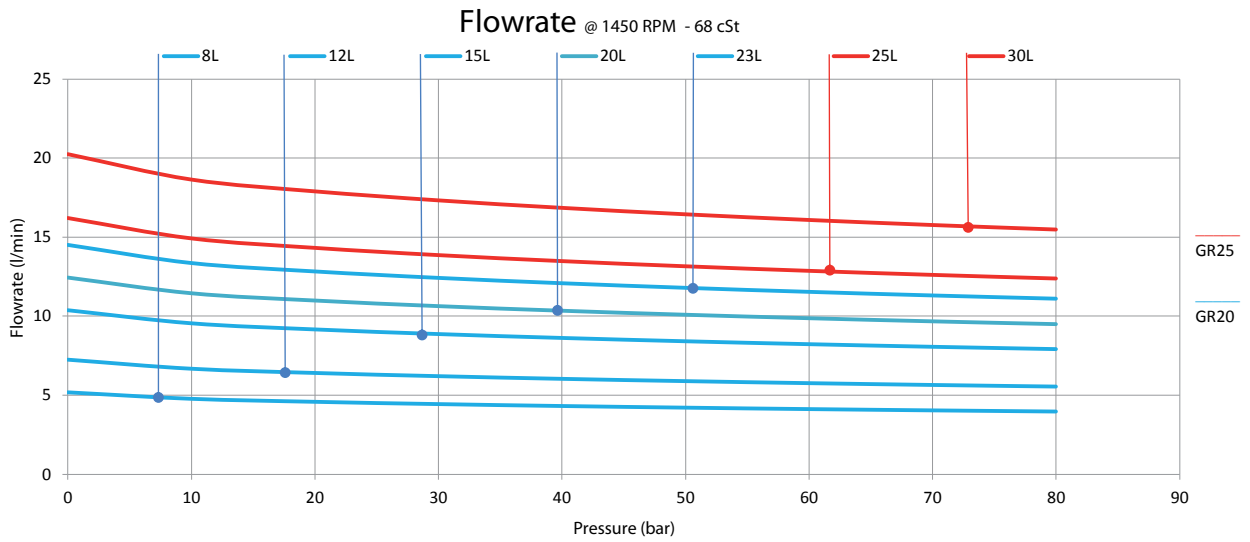
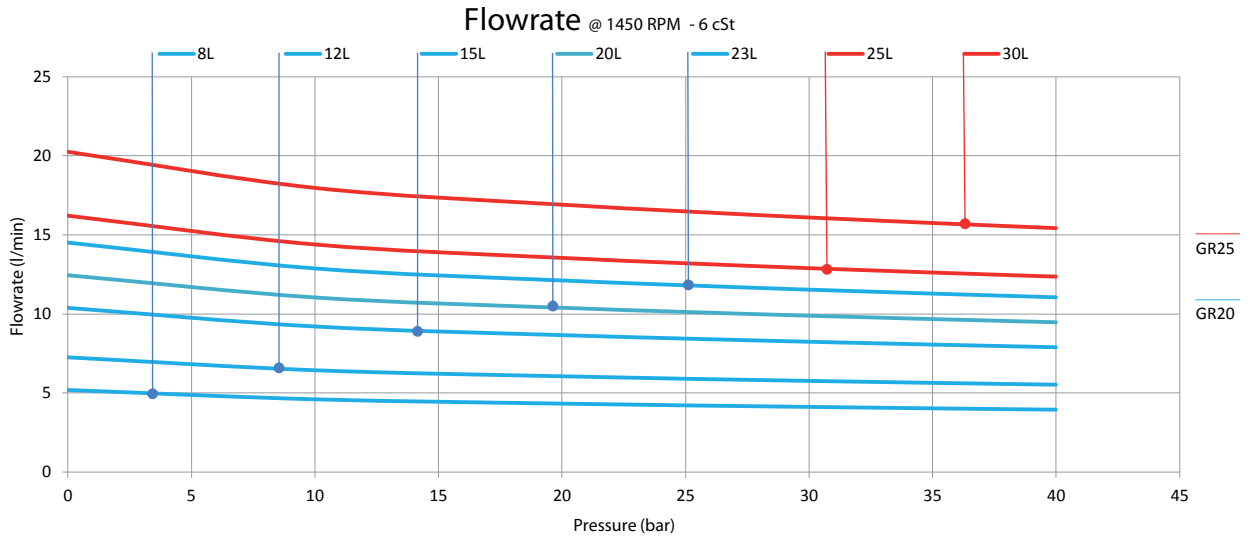

Performances @ 1500 - GR 20-25

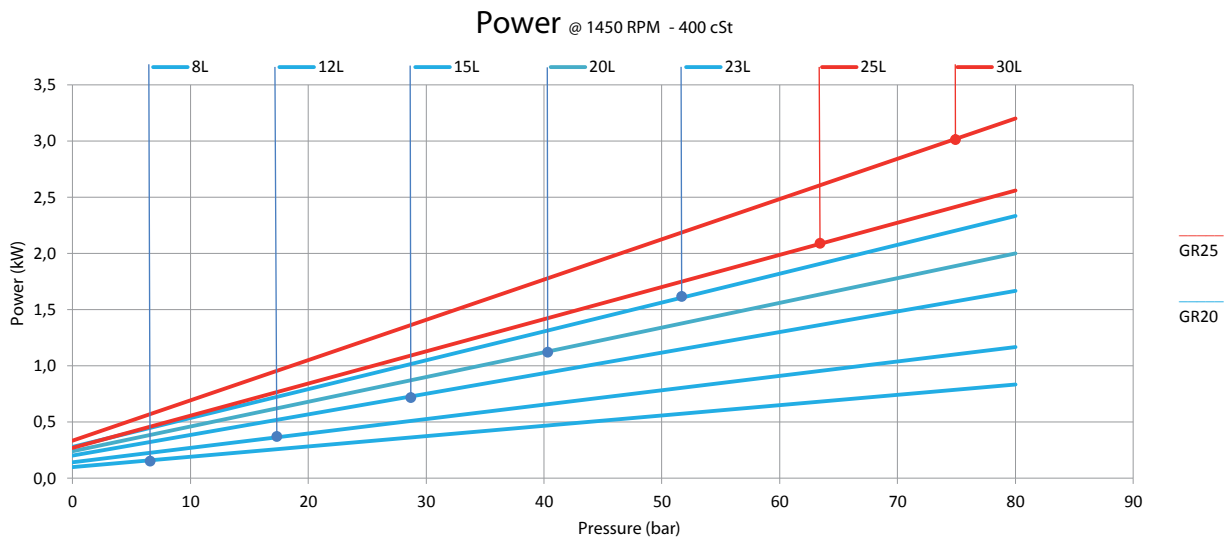
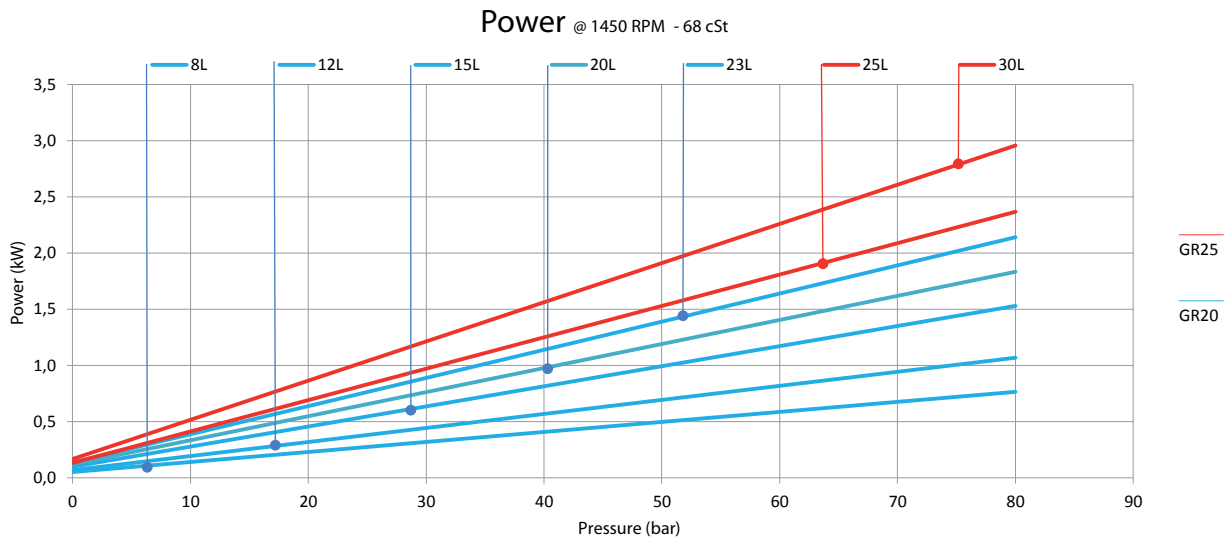
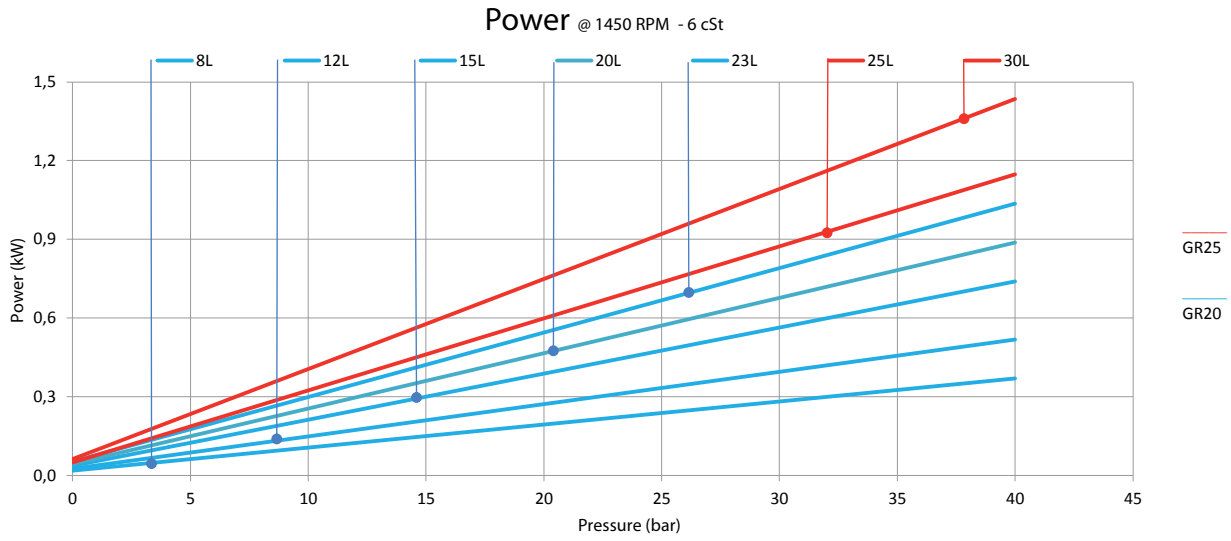

Performances @ 3000 - GR 20-25

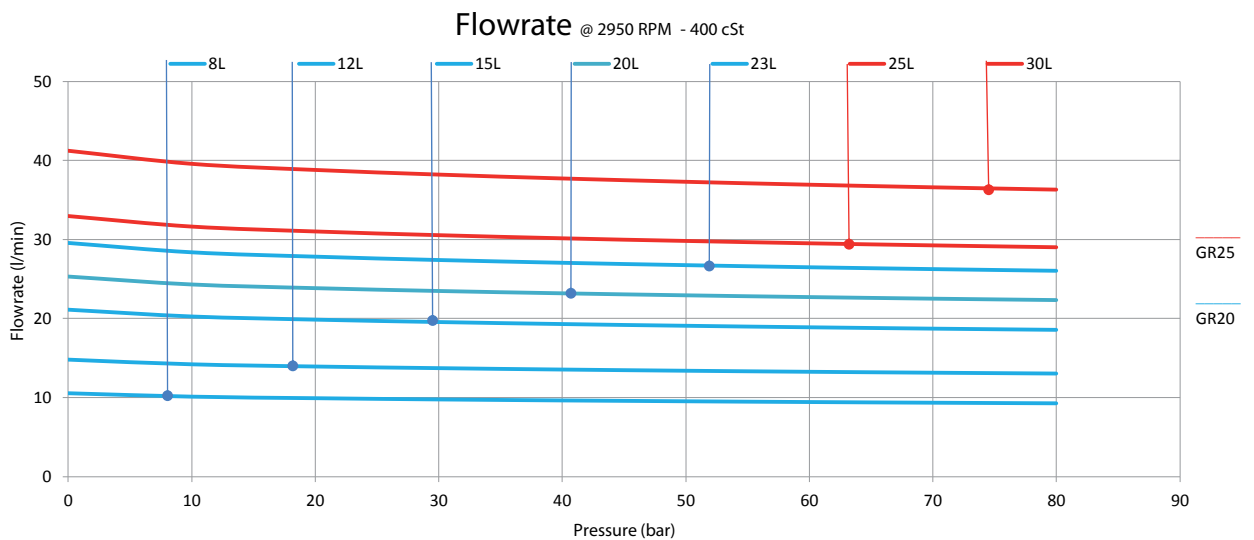
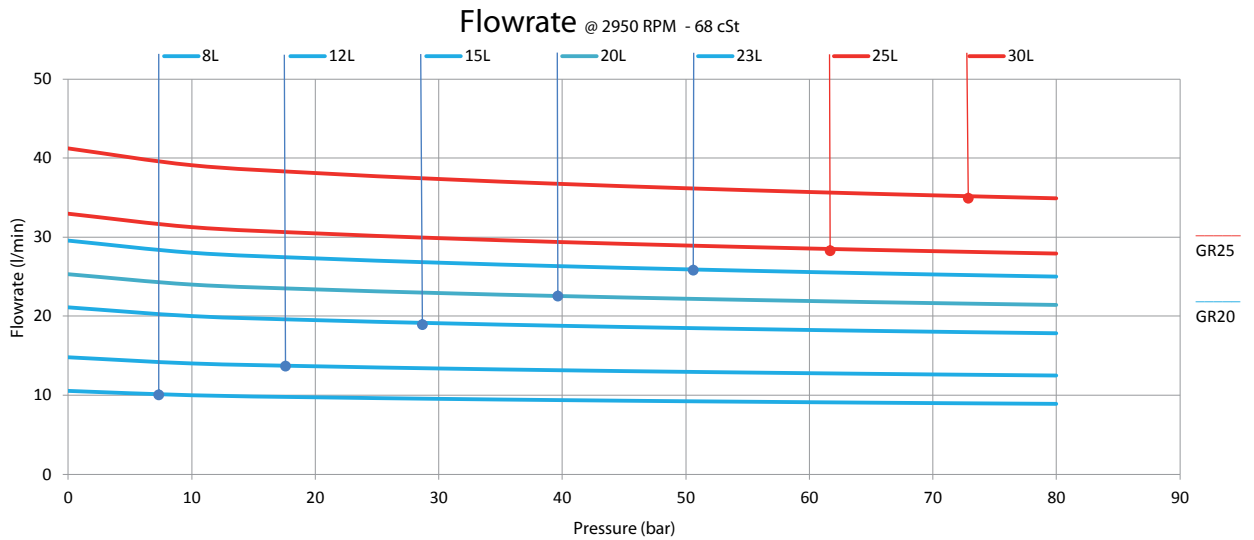
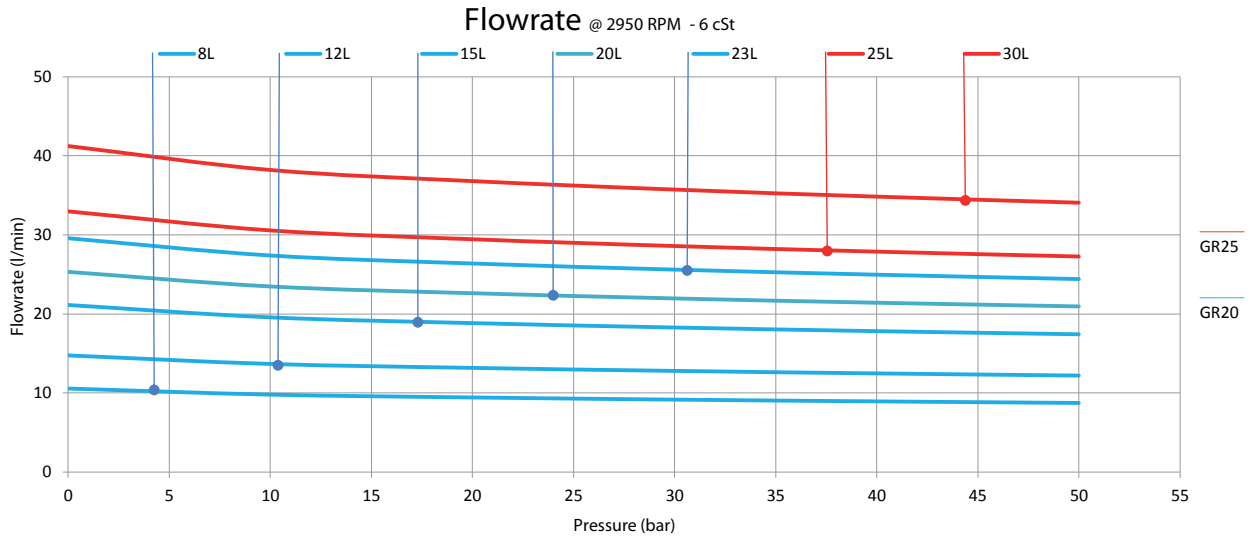

Performances @ 3000 - GR 20-25

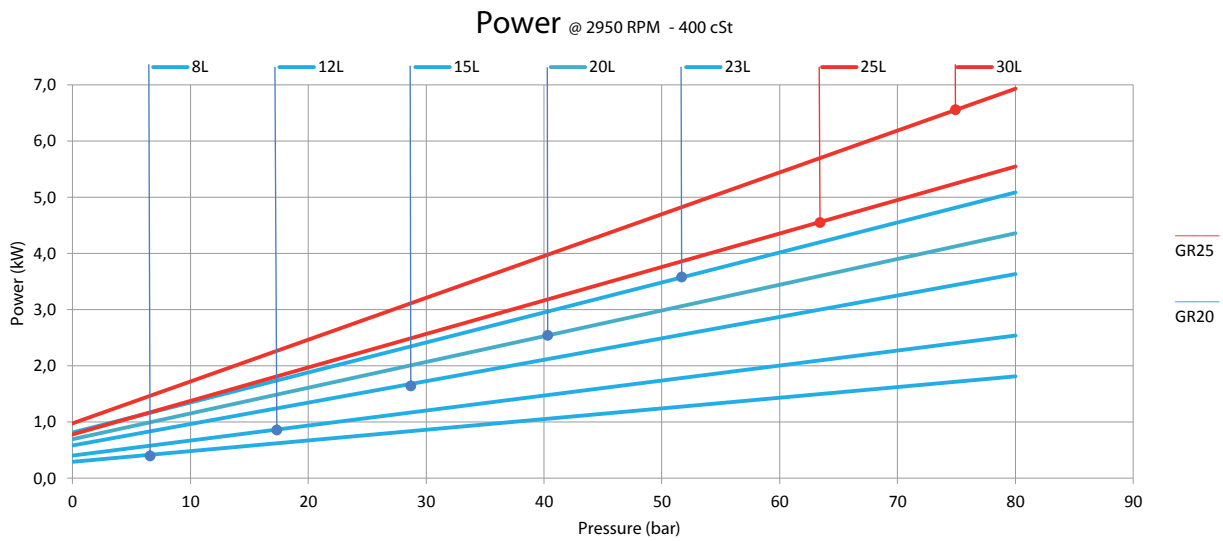
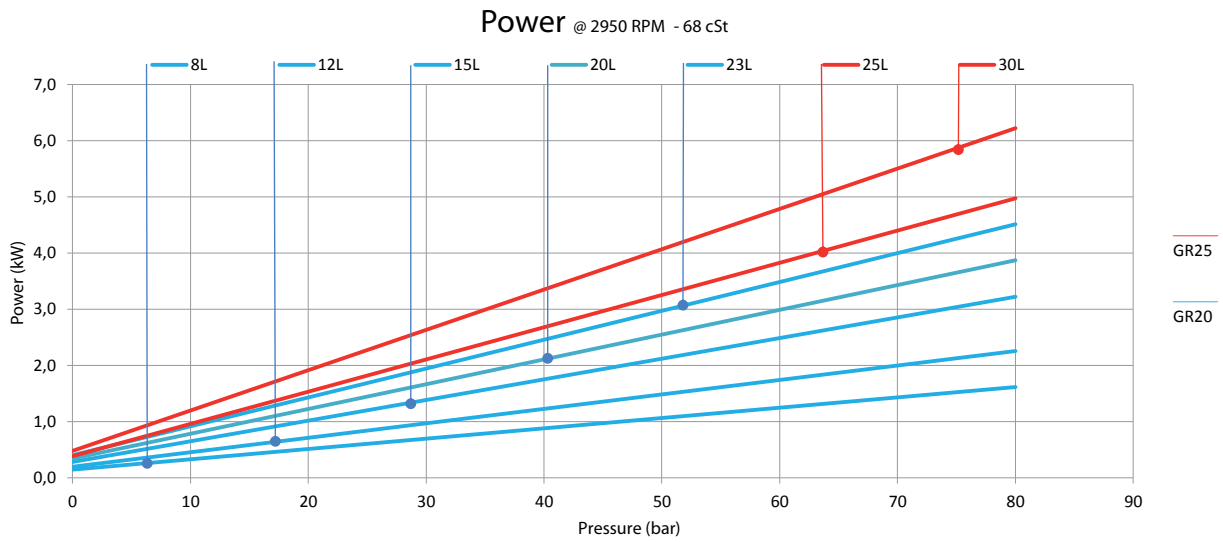
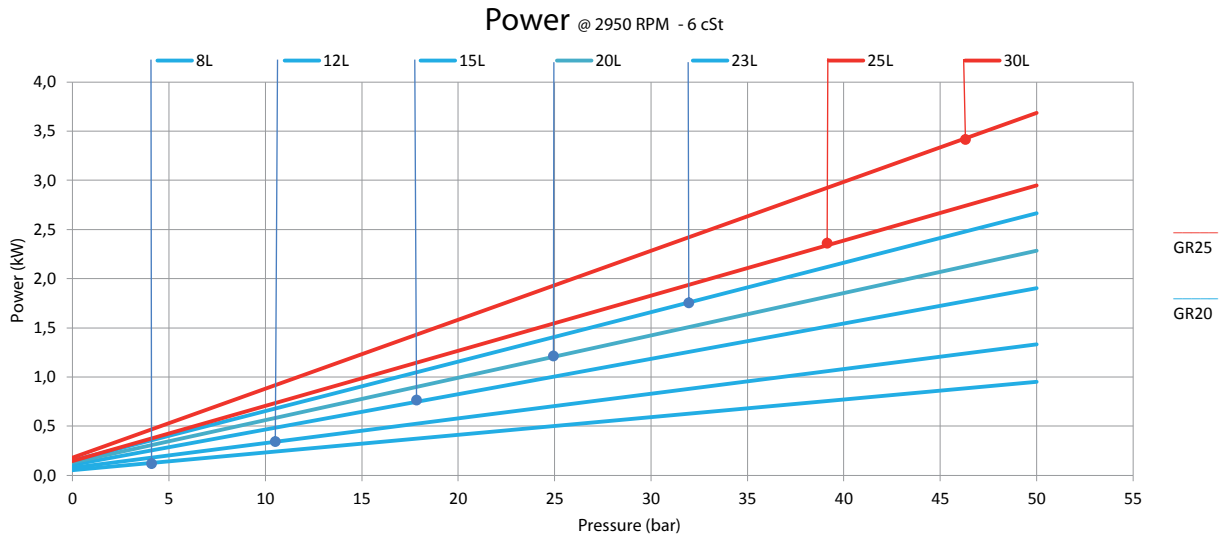

Performances @ 1500 - GR 32-40-45

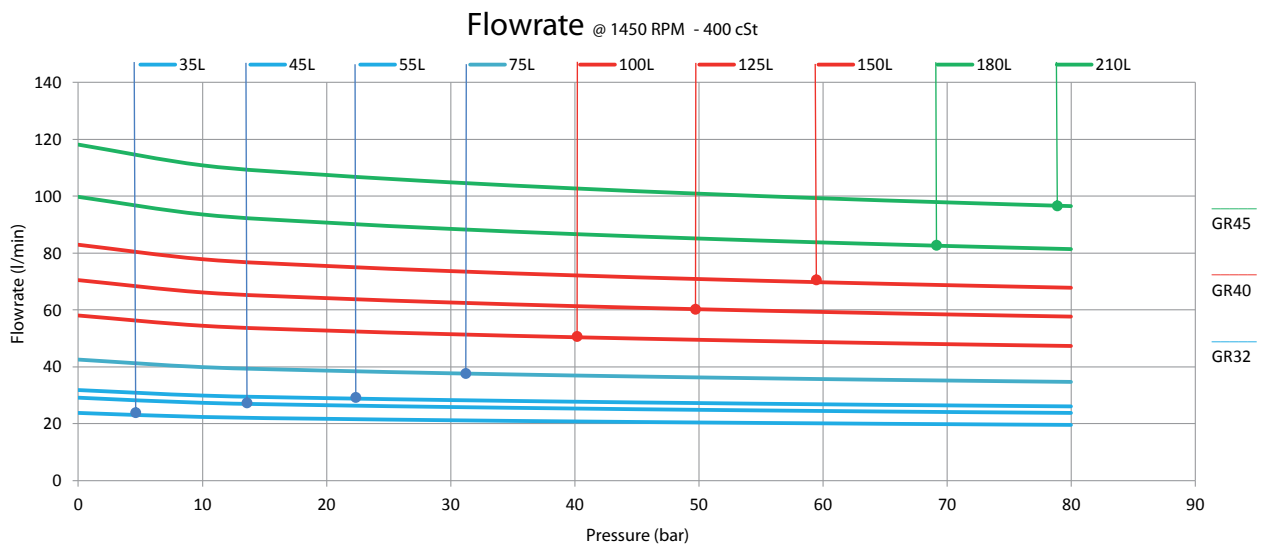
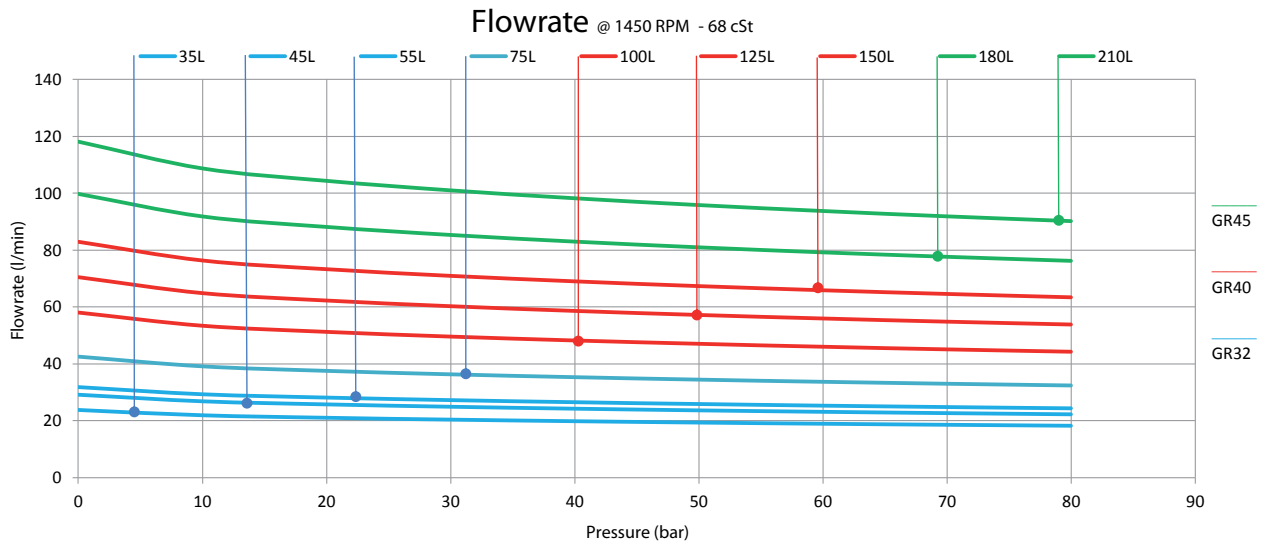
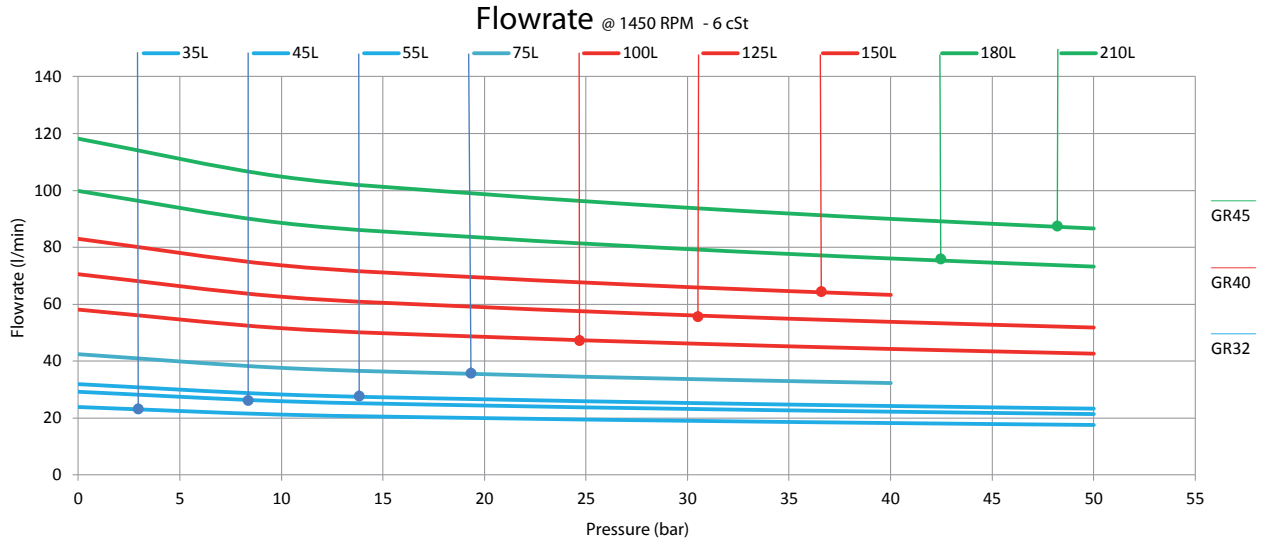

Performances @ 1500 - GR 32-40-45

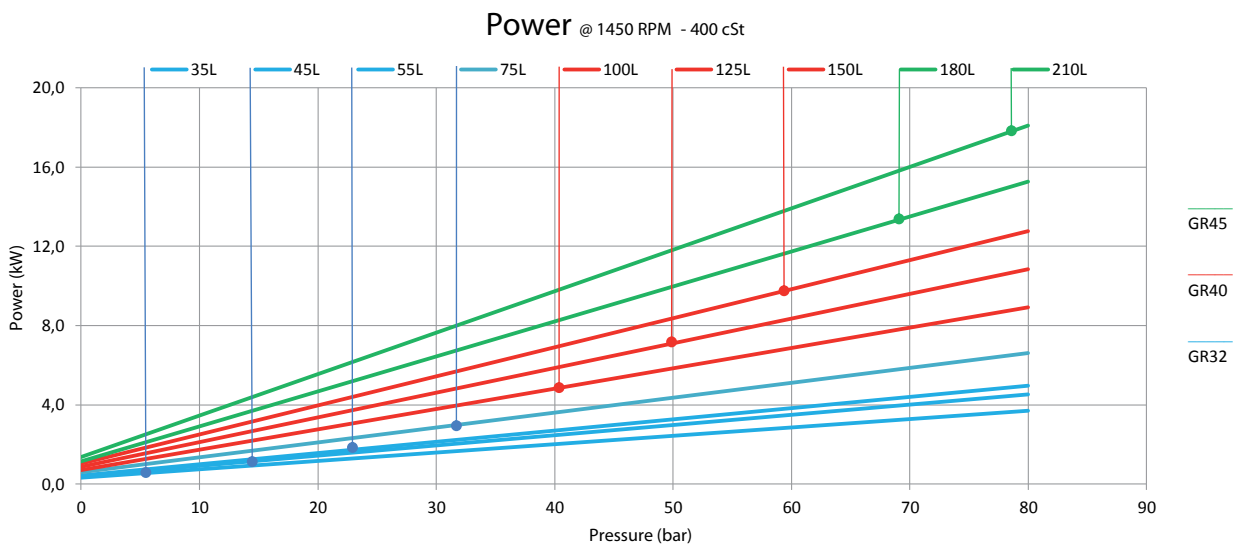
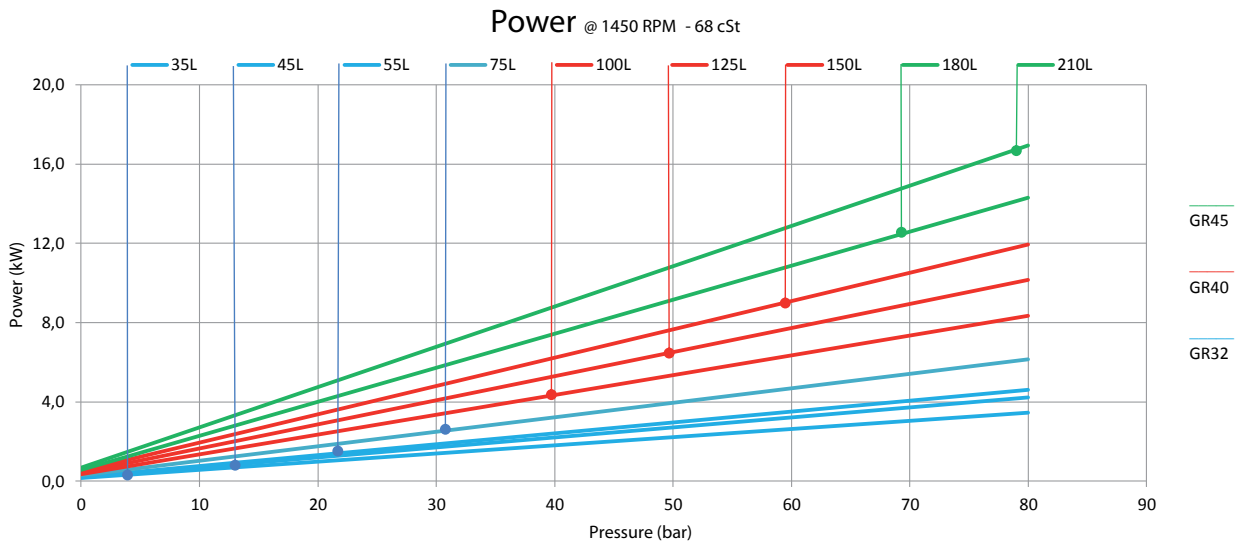
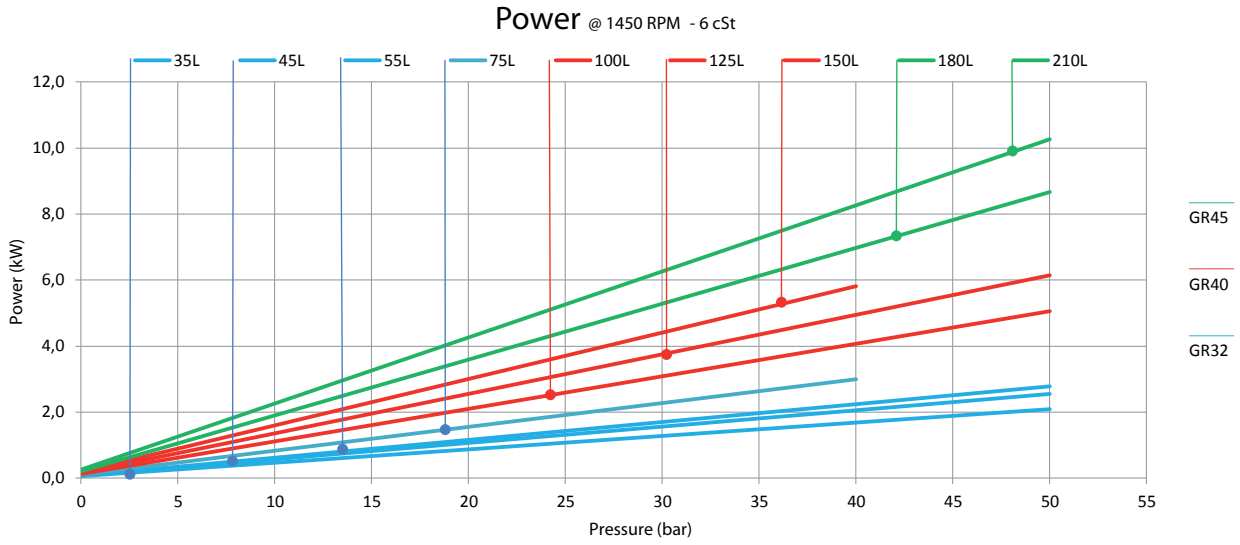

Performances @ 3000 - GR 32-40-45

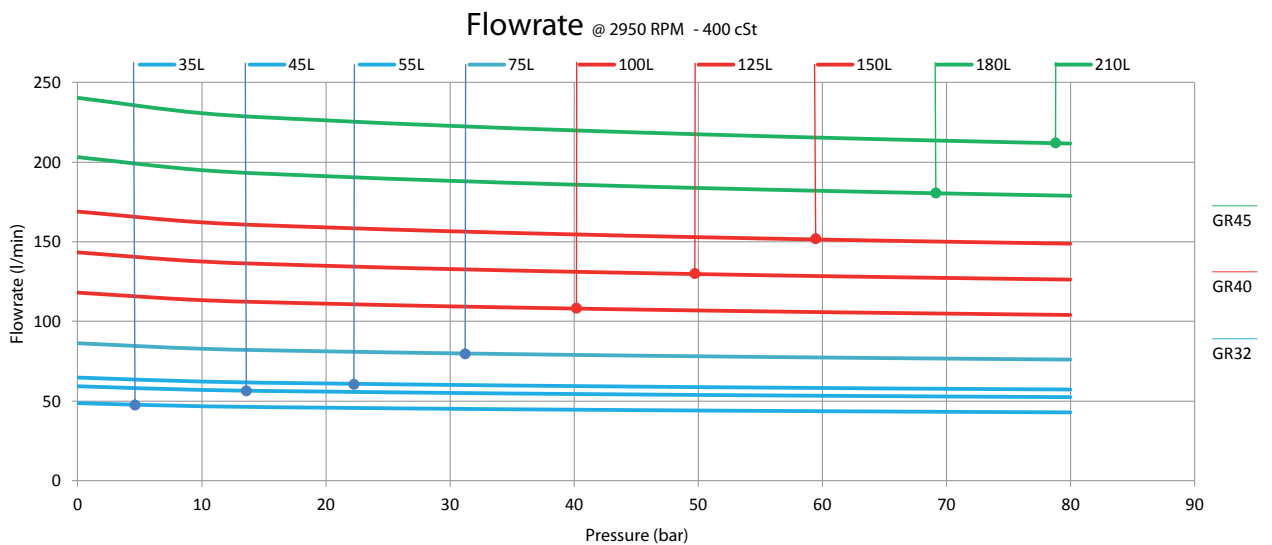
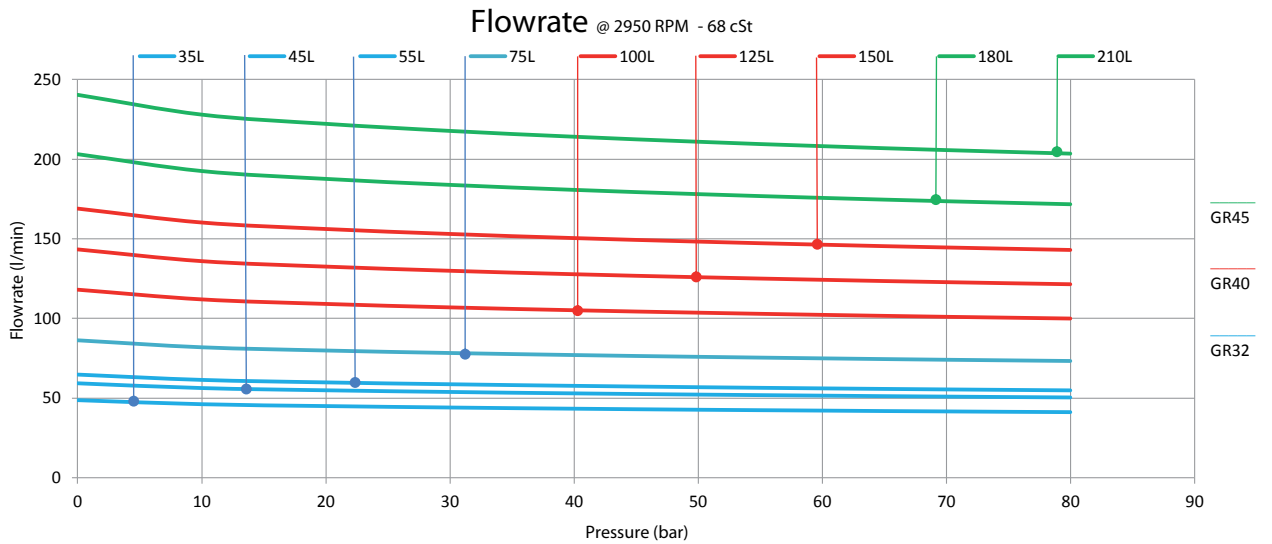
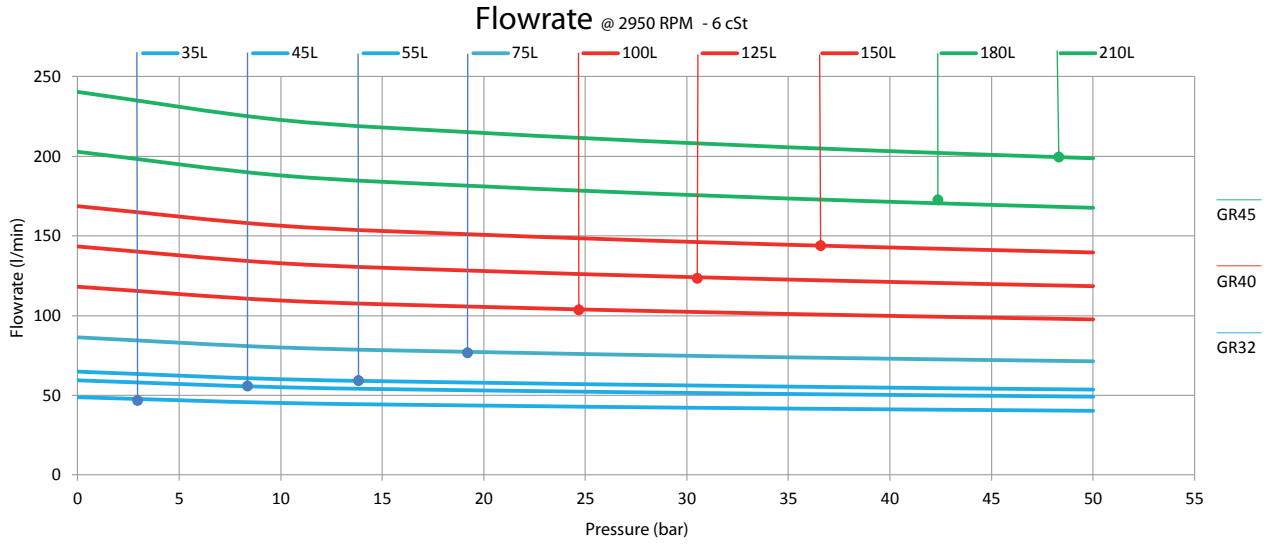

Performances @ 3000 - GR 32-40-45

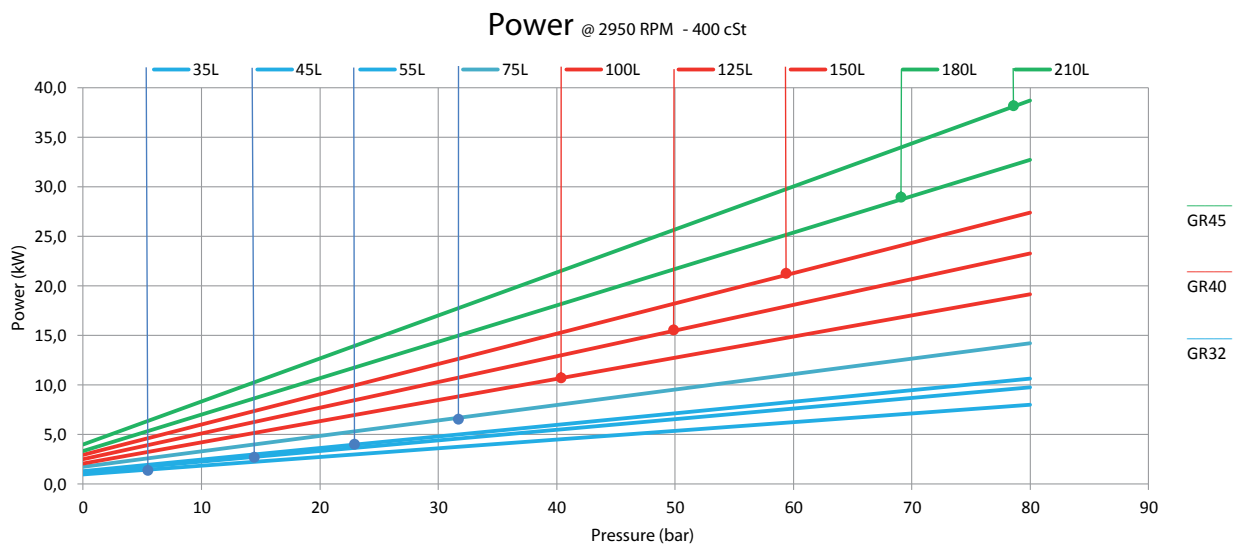
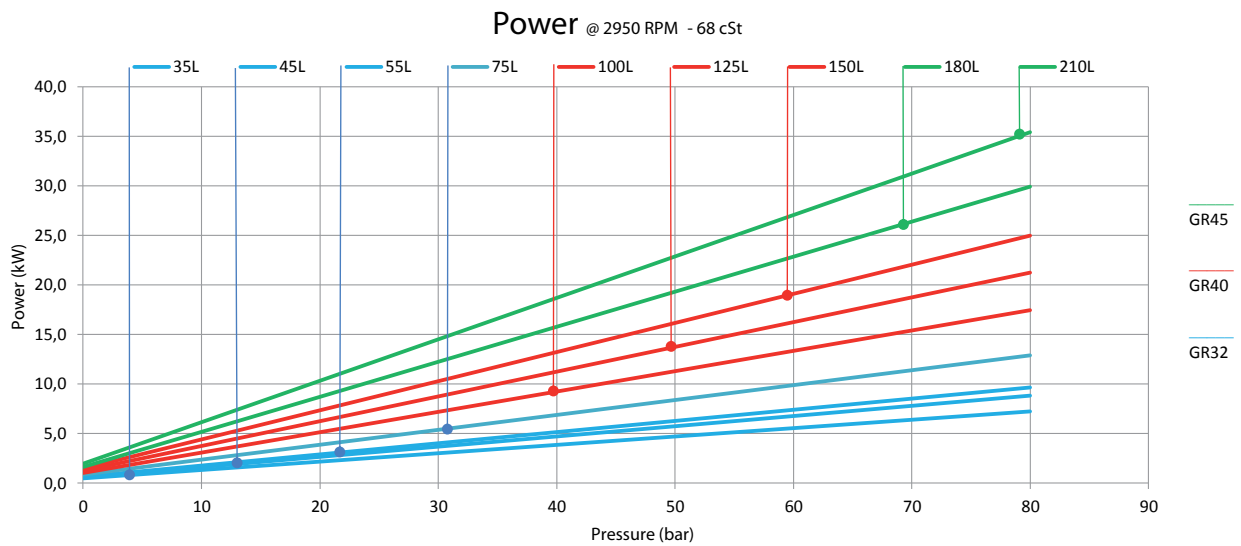
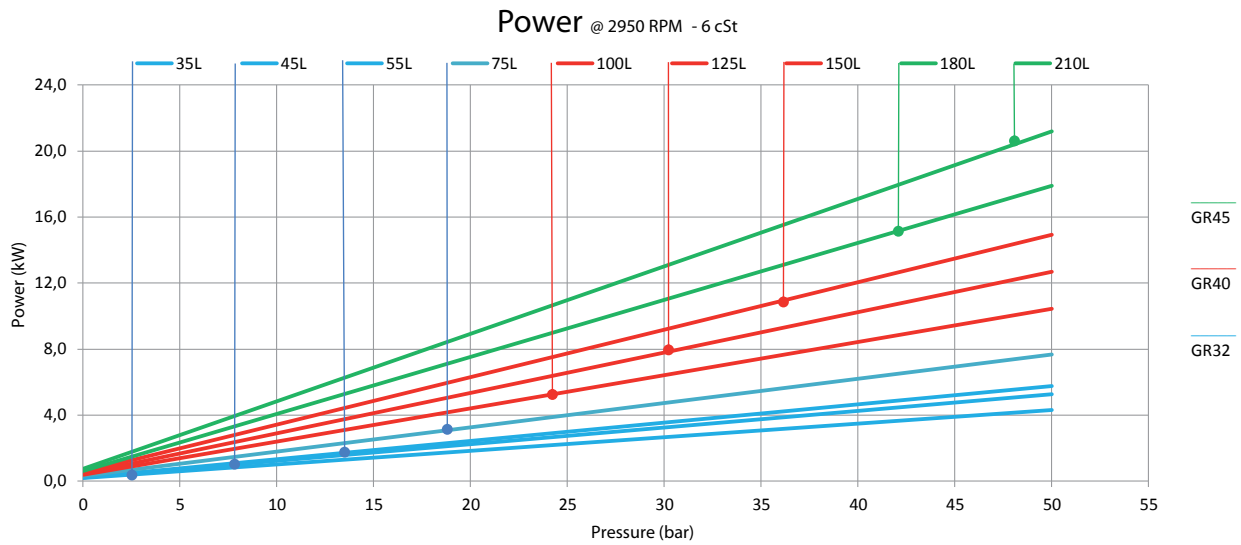

Performances @ 1500 - GR 55-60-70-80-90

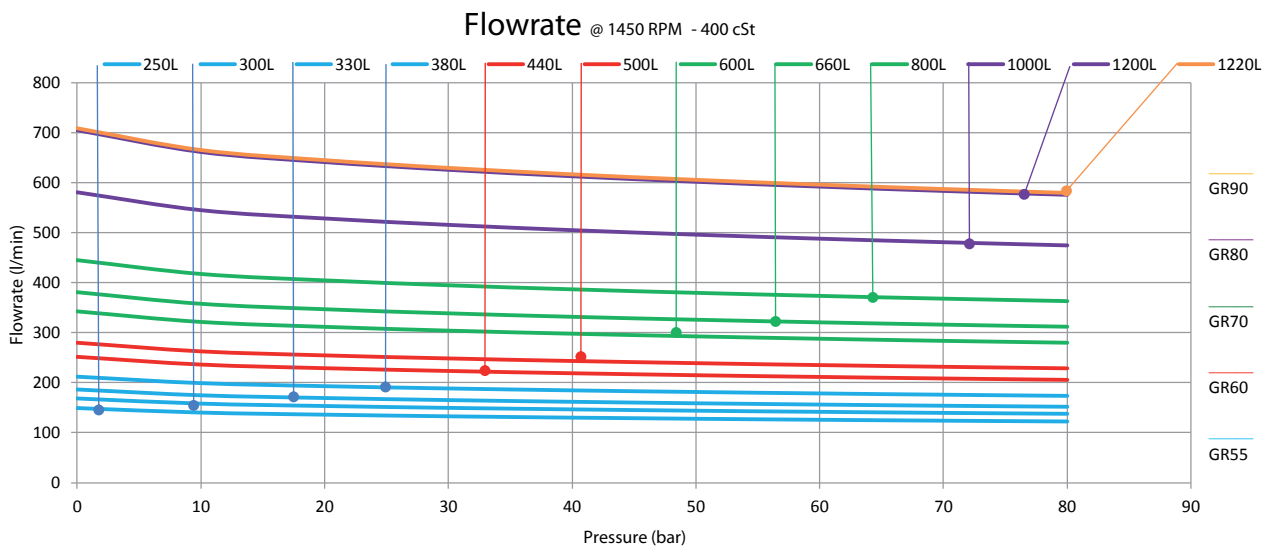
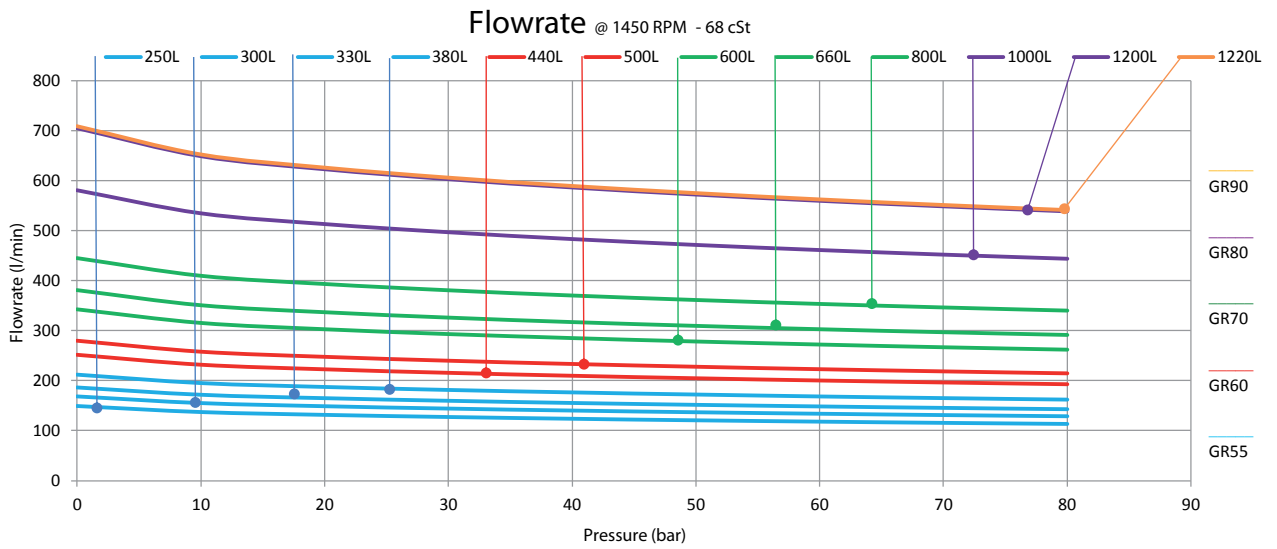
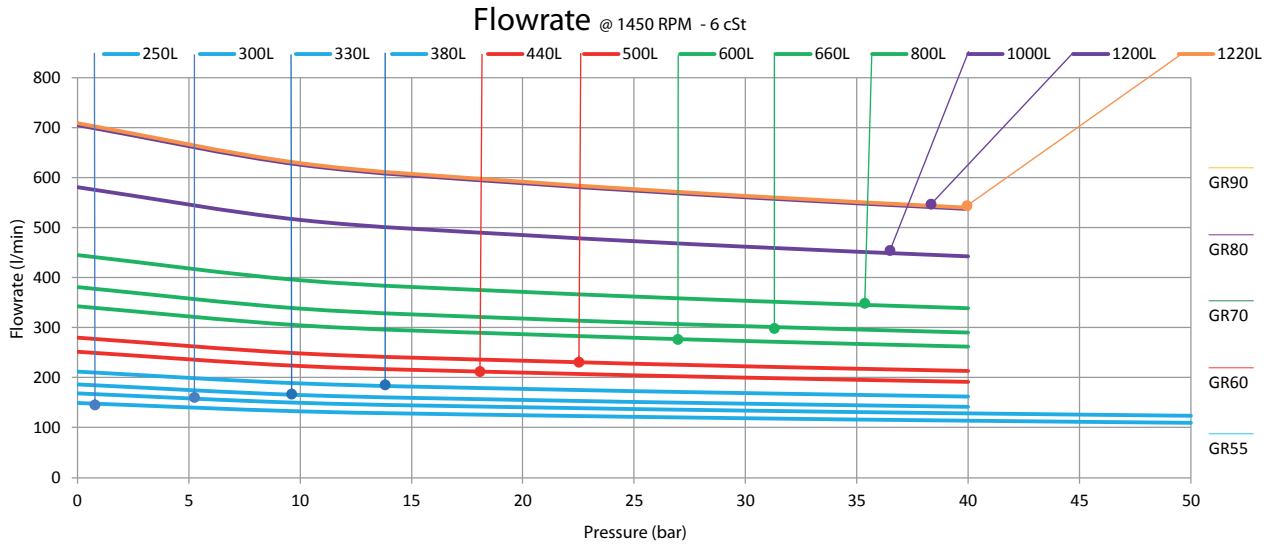

Performances @ 1500 - GR 55-60-70-80-90

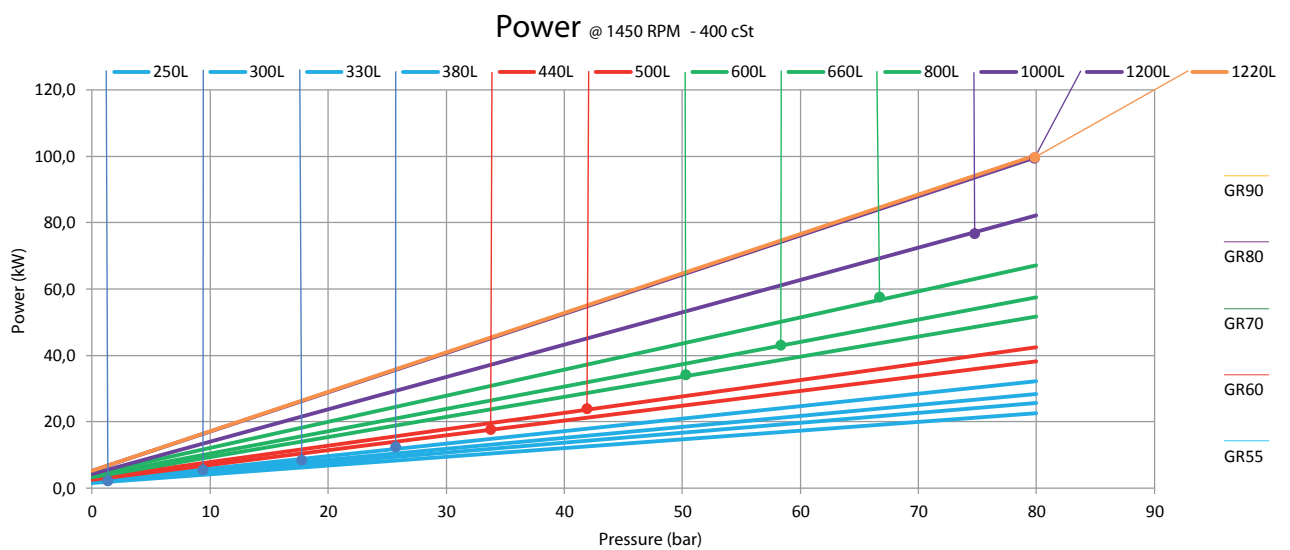
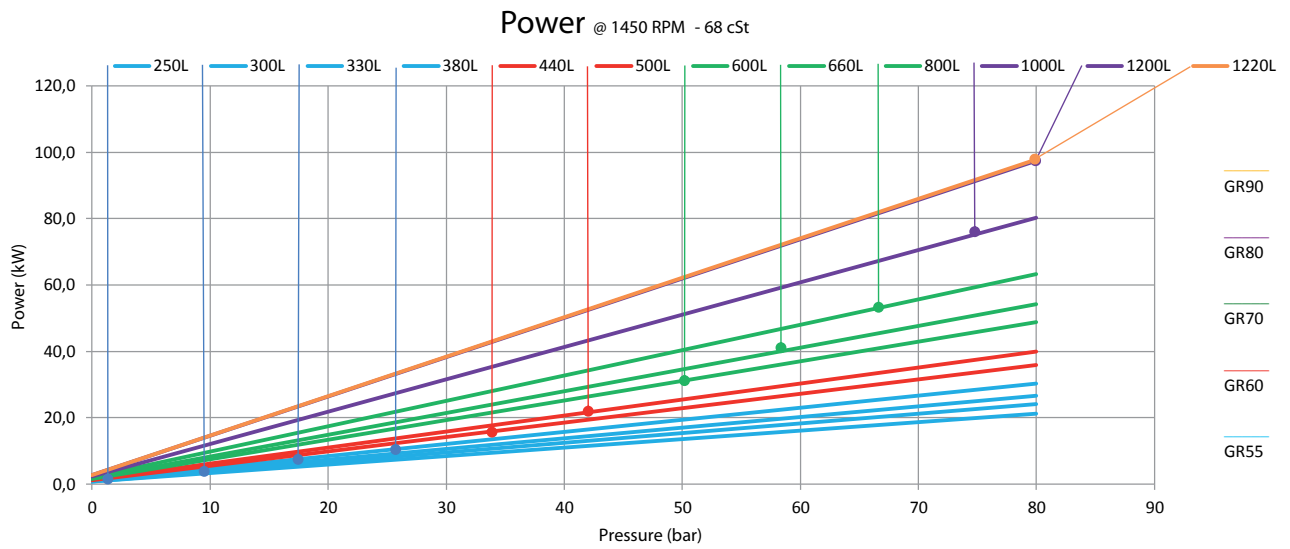
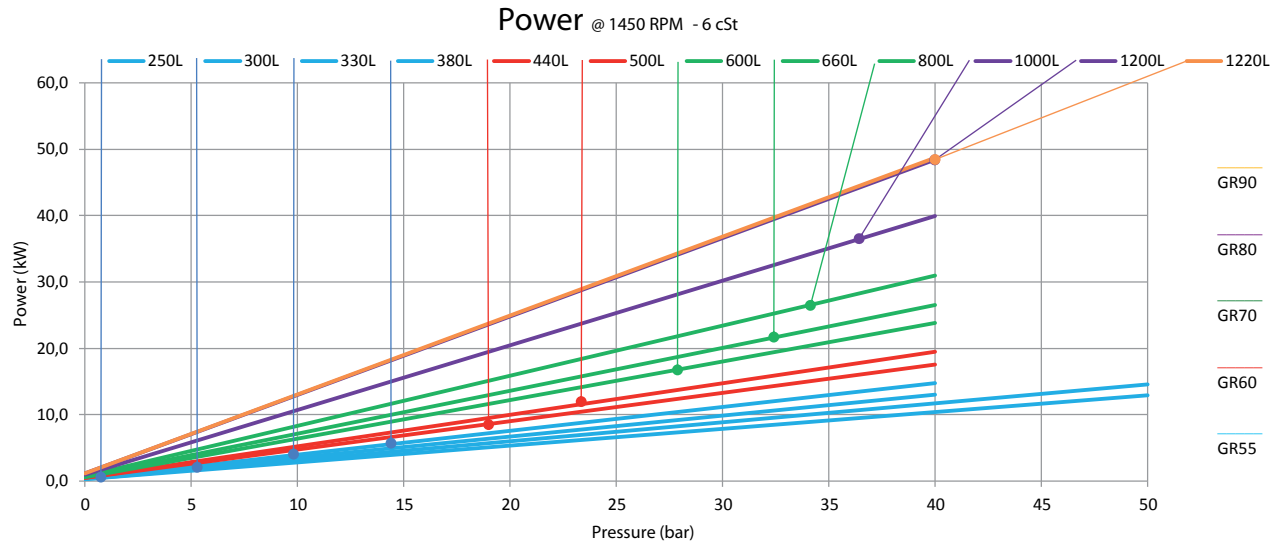

Performances @ 3000 - GR 55-60-70-80-90

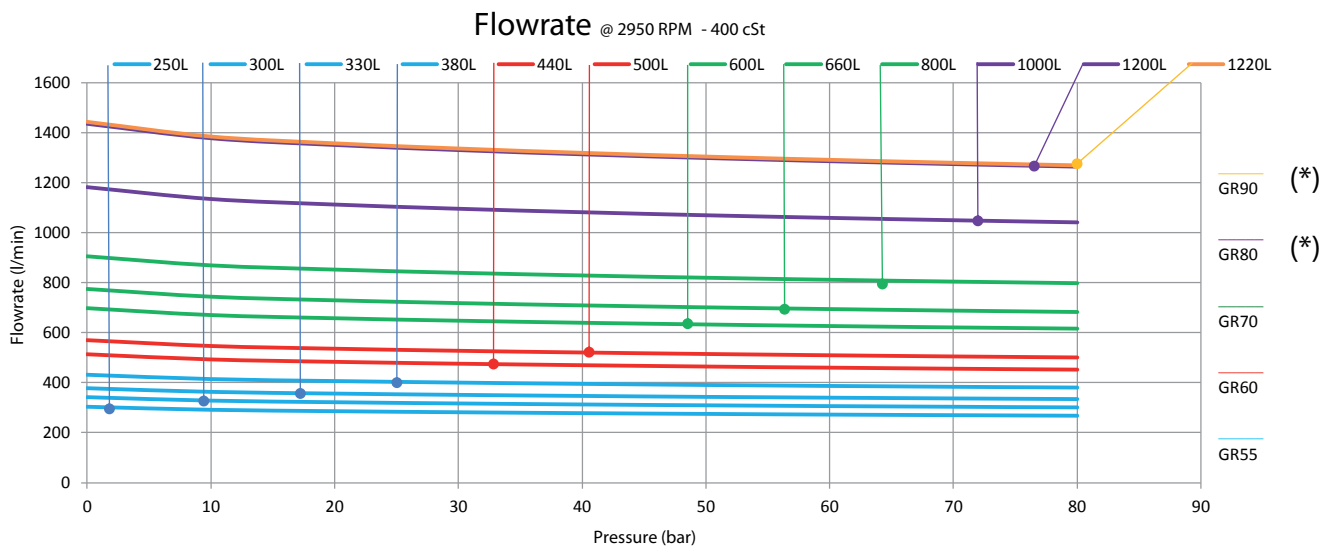
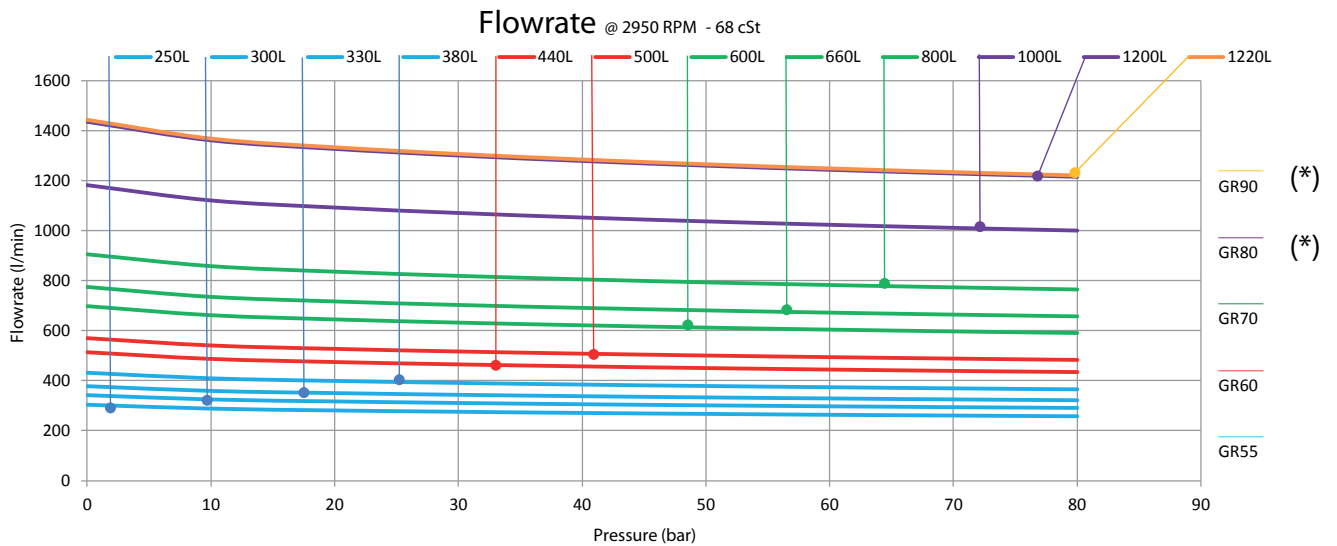
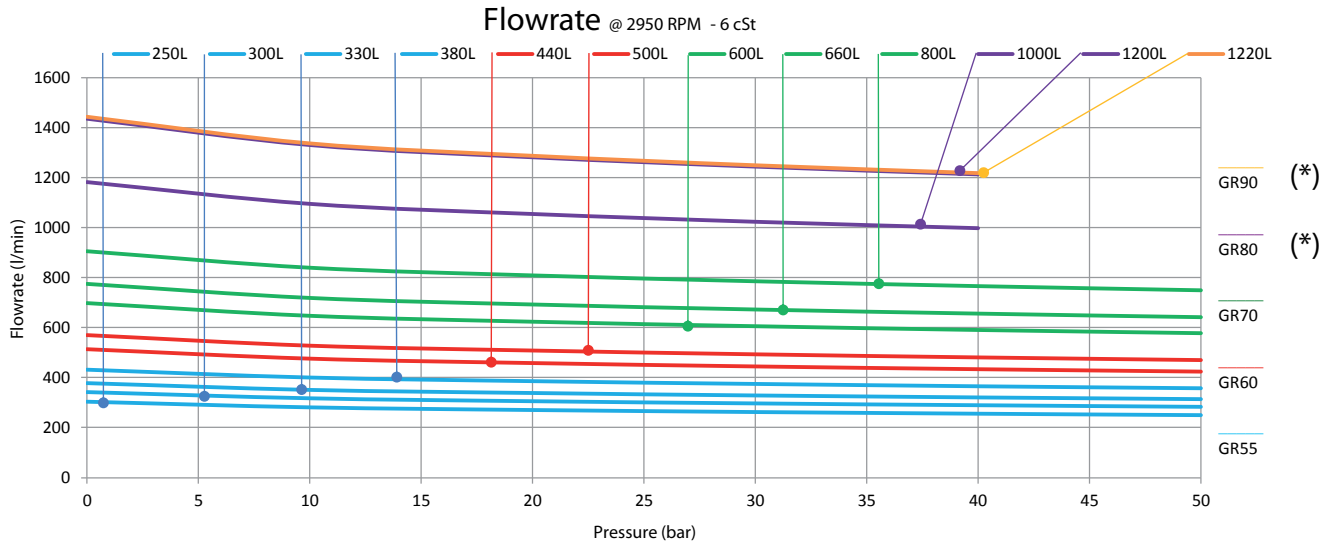

(*) For shaft speed lower than 1.000 rpm and over 1.800 rpm please contact Settima. Per velocità inferiori a 1.000 rpm e maggiori di 1.800 rpm contattare Settima.

Performances @ 3000 - GR 55-60-70-80-90

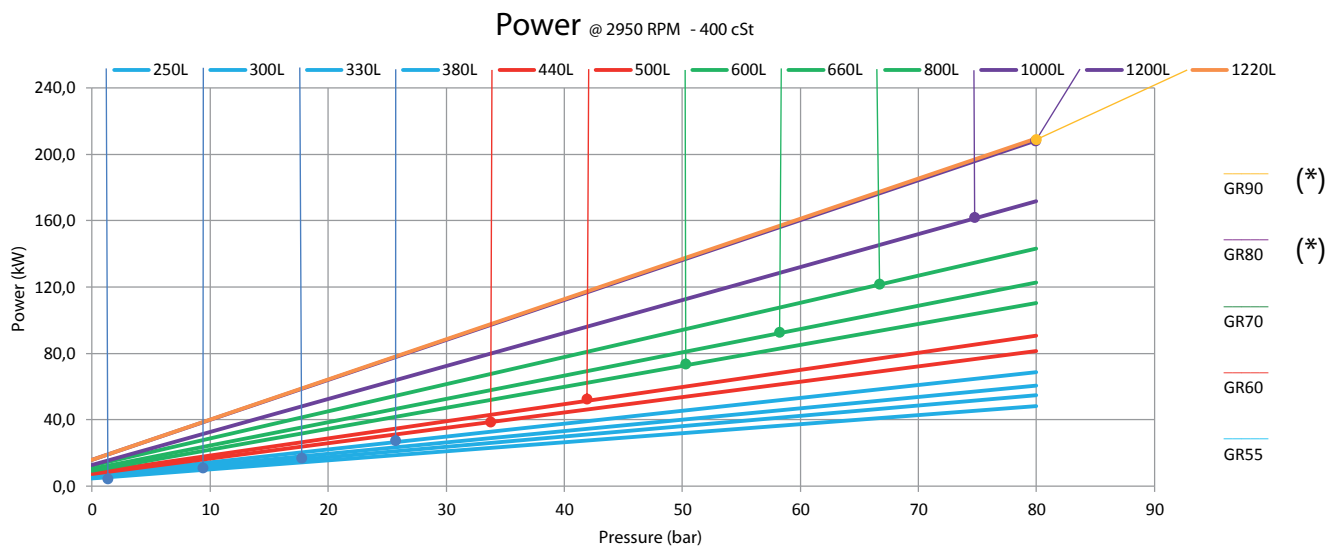
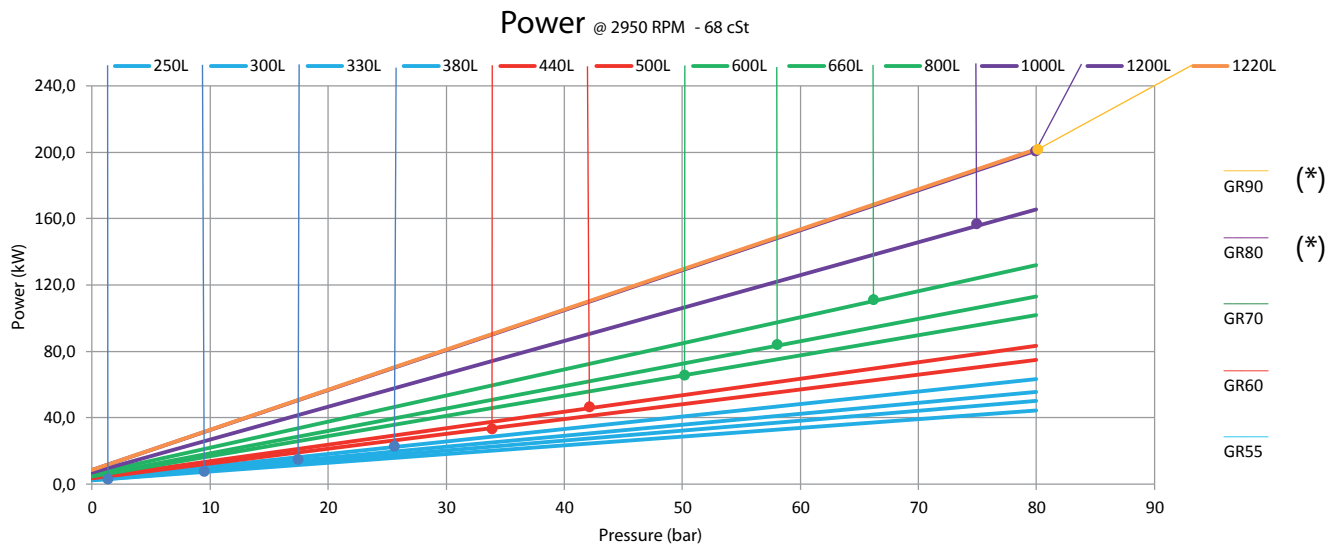
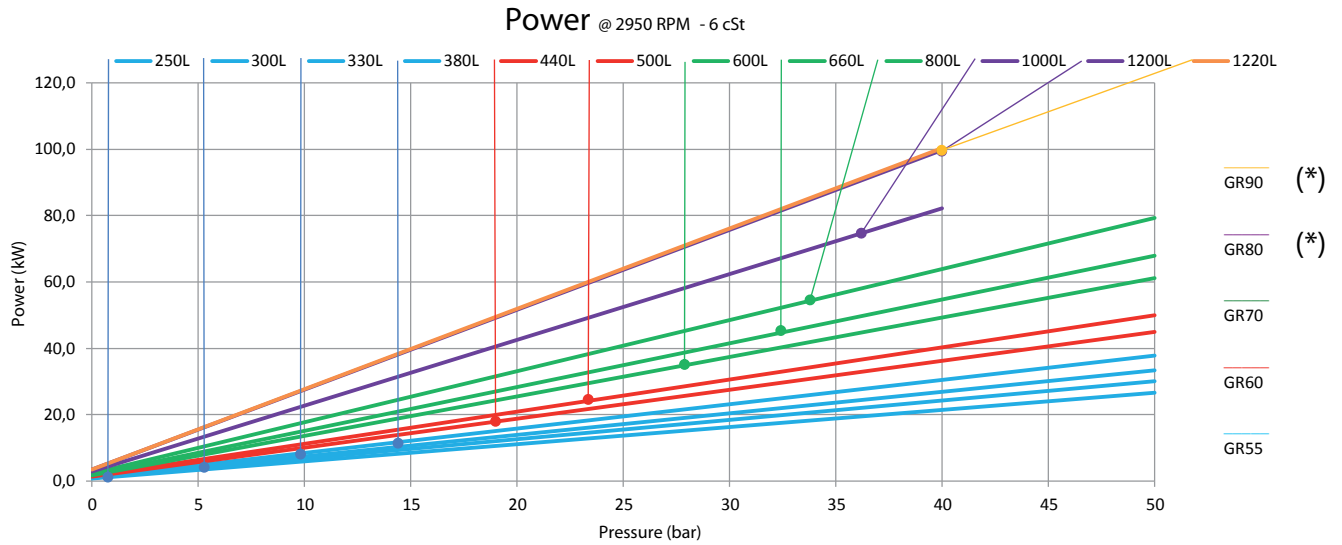

(*) For shaft speed lower than 1.000 rpm and over 1.800 rpm please contact Settima. Per velocità inferiori a 1.000 rpm e maggiori di 1.800 rpm contattare Settima. All data reported by catalogue can change without any notice. I dati presenti nel catalogo possono cambiare senza preavviso.

SETTIMA

Settima, Italy

Headquarter, r&d and production

SETTIMA

USA
Warehouse

SETTIMA

ASIA Ltd.
Sales Office



Settima Meccanica Srl

Settima - 29020 Piacenza (Italia)

tel. +39 0523.3650

fax +39 0523.3650299

www.settima.it

info@settima.it

SETTIMA
research & innovation, always